

Schaltplan

COOL-LINE-Eiswürfelbereiter SDH 24 L

[Art. 41330241063]

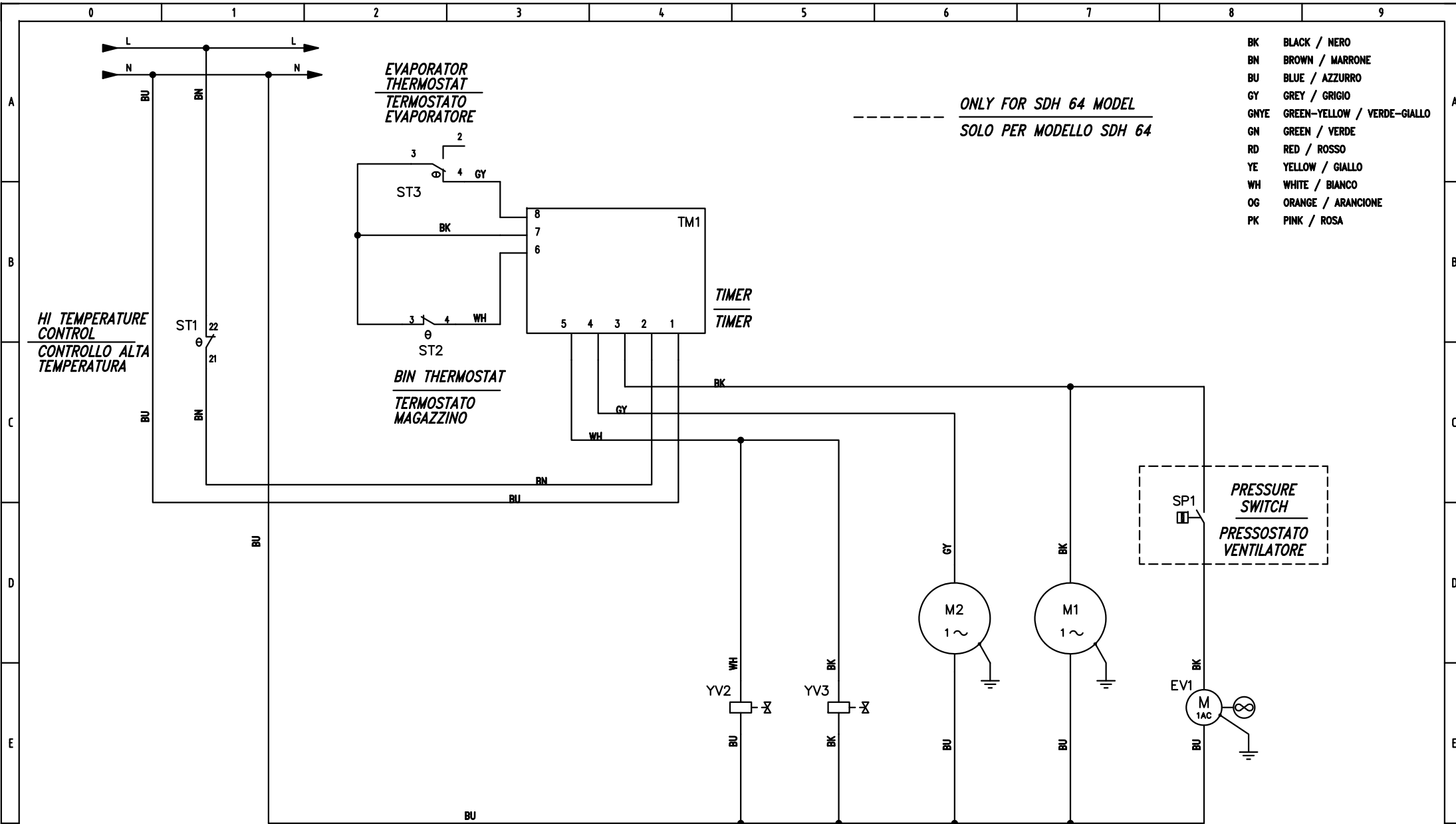



- BK BLACK / NERO
- BN BROWN / MARRONE
- BU BLUE / AZZURRO
- GY GREY / GRIGIO
- GNYE GREEN-YELLOW / VERDE-GIALLO
- GN GREEN / VERDE
- RD RED / ROSSO
- YE YELLOW / GIALLO
- WH WHITE / BIANCO
- OG ORANGE / ARANCIONE
- PK PINK / ROSA

00 - EMISSIONE











| | | | | | | |
|------|----------|----|----------|-------|---------|-------------|
| 00 | 18_224 | LB | 12.12.18 | | DATA | 12.12.18 |
| | | | | | DISEGN. | L.BOCA |
| | | | | | VISTO | G.ROMAGNOLI |
| REV. | MODIFICA | SG | DATA | FIRMA | APPR. | G.ROMAGNOLI |

SCHEMA ELETTRICO
 ELECTRICAL WIRING DIAGRAM

SDH 18/24/30/40/50/64



| | |
|------------------|-----------------|
| 230 Vac 50/60 Hz | = = |
| 050578-03 | + + |
| 00 | FG. 2 F.S. 4 |

| Sim.\Sym | Sigla\Item | Funzione\Use Type | Sim.\Sym | Sigla\Item | Funzione\Use Type | Sim.\Sym | Sigla\Item | Funzione\Use Type |
|---|------------|--|----------|------------|-------------------|----------|------------|-------------------|
|  | EV1 | Fan motor Ventilatore | | | | | | |
|  | M1 | Compressor Compressore | | | | | | |
|  | M2 | Water pump Pompa acqua | | | | | | |
|  | ST1 | HI Temperature control Controllo alta temperatura | | | | | | |
|  | ST2 | Bin thermostat Termostato magazzino | | | | | | |
|  | ST3 | Evaporator thermostat Termostato evaporatore | | | | | | |
|  | TM1 | Electronic timer Timer elettronico | | | | | | |
|  | YV2 | Water inlet valve Elettrovalvola ingresso acqua | | | | | | |
|  | YV3 | Hot gas valve Elettrovalvola gas caldo | | | | | | |
|  | SP1 | Fan pressure switch Pressostato ventilatore | | | | | | |
| | | | | | | | | |

00 - EMISSIONE

| | | | | | | | | | | | | | | | |
|------|----------|----|----------|-------|---------|-------------|-----------------------------------|----------|------------|-----------------------|--|------------------|-----------|-----|-----------------|
| 00 | 18_224 | LB | 12.12.18 | | DATA | 12.12.18 | LEGENDA SIMBOLI SYMBOLS LEGEND | | | SDH 18/24/30/40/50/64 |  Ice Systems | 230 Vac 50/60 Hz | | = = | |
| | | | | | DISEGN. | L.BOCA | | | | | | + | | | |
| | | | | | VISTO | G.ROMAGNOLI | | | | | | | | | |
| REV. | MODIFICA | SG | DATA | FIRMA | APPR. | G.ROMAGNOLI | SOST. IL : | 12.12.18 | SOST. DA : | G.ROMAGNOLI | FILE : | 05057830.DWG | 050578-03 | 00 | FG. 3 F.S. 4 |

Finanzen/Service
28307 Bremen
Thalendorststraße 15
Tel.+49 421 48557-0
Fax+49 421 488650
bremen@nordcap.de

Vertrieb Ost
12681 Berlin
Wolfener Straße 32/34, Haus K
Tel.+49 30 936684-0
Fax+49 30 936684-44
berlin@nordcap.de

Vertrieb West
40699 Erkrath
Max-Planck-Straße 30
Tel.+49 211 540054-0
Fax+49 211 540054-54
erkrath@nordcap.de

Vertrieb Nord
21079 Hamburg
Großmoorbogen 5
Tel.+49 40 766183-0
Fax+49 40 770799
hamburg@nordcap.de

Vertrieb Süd
55218 Ingelheim
Hermann-Bopp-Straße 4
Tel.+49 6132 7101-0
Fax+49 6132 7101-20
ingelheim@nordcap.de



www.nordcap.de