

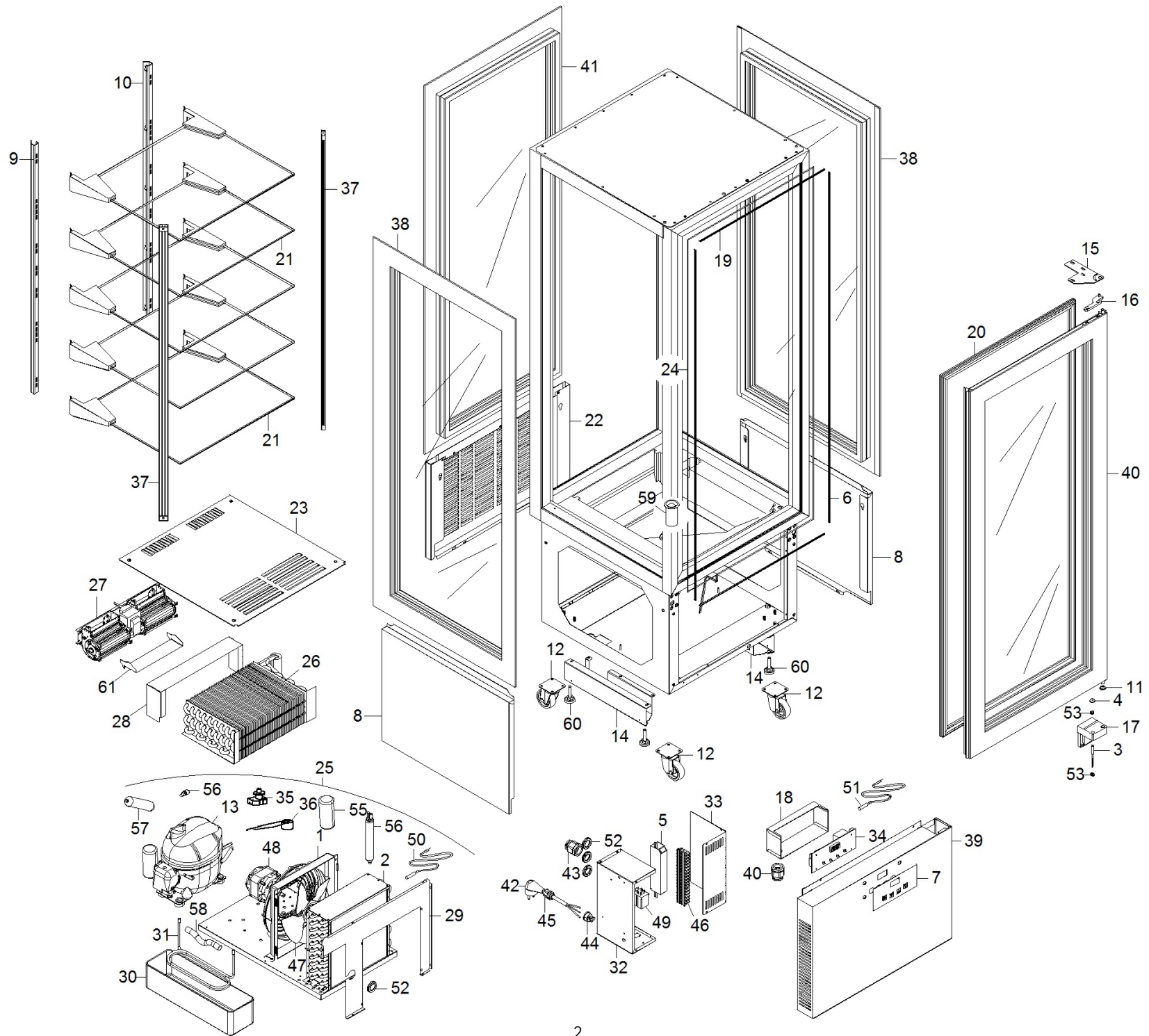











Ersatzteilliste-Explosionszeichnung





Panorama-Kühlvitrine LUXOR SLIM

























[Art. 458100002]





	Aenderung	 	Bestellnummer		Beschreibung	 Empf.	Menge	Gultigkeit datum
		1	3097420		VENTILATORSCH.		1	15/05/2015-
		2	3098250		KONDEN.+HAUBE		1	15/05/2015-
		3	3107780		MIKROSCHALTER	X	1	15/05/2015-
		4	3107790		MAGNET		1	15/05/2015-
		5	3161390		ALIMENTEUR ÉLECTRIQUE	X	1	15/05/2015-
		6	3163370		PROFIL		2	15/05/2015-
		7	3163850		SIEBGEDR. TAFEL	X	1	15/05/2015-
		8	3163910		SEITLICHE WAND		2	15/05/2015-
		9	3164260		ZAHNSTANGE		1	15/05/2015-
		10	3164680		ZAHNSTANGE		1	15/05/2015-
		11	3166060		UNTERLEGSCHIEBE		1	15/05/2015-
		12	3264120		RAD		4	20/07/2017-
		13	3179290		KOMPRESSOR	X	1	15/05/2015-
		14	3181430		HALTER		2	15/05/2015-
		15	3187680		OBERKASTEN		1	15/05/2015-
		16	3187690		TÜR HALTERUNG		1	15/05/2015-
		17	3187700		UNTERER BUEGEL		1	15/05/2015-
		18	3217420		KARTENSCHUTZ		1	15/05/2015-
		19	3263750		PROFIL		2	15/05/2015-
		20	3263780		DICHTUNG	X	1	15/05/2015-

	Aenderung	 ↑↓	Bestellnummer	↑↓	Beschreibung	↑↓	Empf.	Menge	Gultigkeit datum
			21	3263820		EINLEGEBORETT		5	15/05/2015-
			22	3263850		RÜCKWAND		1	15/05/2015-
			23	3263890		UNTERE WAND		1	15/05/2015-
			24	3264130		WIDERSTAND	X	1	15/05/2015-
			25	3264230		AGGREGAT		1	15/05/2015-
			26	3264260		VERDAMPFER	X	1	15/05/2015-
			27	3333780		TANGENZ.VENTIL.	X	1	20/12/2017-
			28	3264350		KUEHLERHAUBE		1	15/05/2015-
			29	3264360		KUEHLERHAUBE		1	15/05/2015-
			30	3264420		KONDENSSCHALE		1	15/05/2015-
			31	3264430		SCHLANGE		1	15/05/2015-
			32	3264510		SCHUTZHALHAUPTSCHALTER		1	15/05/2015-
			33	3264520		SCHALTAFELDECKEL		1	15/05/2015-
			34	3265510		ELEKTROKARTE	X	1	15/05/2015-
			35	3293380		RELAY	X	1	15/05/2015-
			36	3293390		MOTORSCHULTZSHALTER		1	15/05/2015-
			37	6032950		LED-MODUL	X	2	15/05/2015-
			38	6036690		GLAS		2	15/05/2015-
			39	6039250		SCHALTERBLENDE		1	15/05/2015-15/07/2018
			40	6039260		TUER		1	15/05/2015-

	Aenderung		Bestellnummer		Beschreibung		Empf.	Menge	Gultigkeit datum
		41	6039270		GLAS			1	15/05/2015-
		42	32A2200		SPEISEKABEL			1	15/05/2015-
		43	32D0220		ZUGENTLASTUNG			2	15/05/2015-
		44	32D0680		KABELHALTER			1	15/05/2015-
		45	32D0700		KABELZUGENTLASTUNG			1	15/05/2015-
		46	32D0761		KLEMMBRETT		X	1	15/05/2015-
		47	32M2510		FLÜGELRAD		X	1	15/05/2015-
		48	32M7210		VENTILATORMOTOR		X	1	15/05/2015-
		49	32V3720		RELAY		X	1	15/05/2015-
		50	32V3730		FÜHLER NTC		X	1	15/05/2015-
		51	32V6010		FÜHLER NTC		X	1	15/05/2015-
		52	32X0120		KABELDURCHFÜHRUNG			4	15/05/2015-
		53	32X0340		KABELDURCHFÜHRUNG			2	15/05/2015-
		54	32Z7710		KONDENSATOR		X	1	15/05/2015-
		55	33A0180		FILTER		X	1	15/05/2015-
		56	33A1200		BETRIEBSVENTIL		X	1	15/05/2015-
		57	35W3360		FLÜSSIGKEITSBEHÄLTER			1	15/05/2015-
		58	35X1640		SIPHONABLAß		X	1	15/05/2015-
		59	35X6900		SCHLUSS			1	15/05/2015-
		60	36C0630		FUß			4	15/05/2015-

	Aenderung	 	Bestellnummer		Beschreibung	 Empf.	Menge	Gultigkeit datum
		61	3366640		HALTER		1	20/12/2017-