

Masszeichnung Salatbar TR-GREEN 6/1 SERVICE

[Art. 434703801]

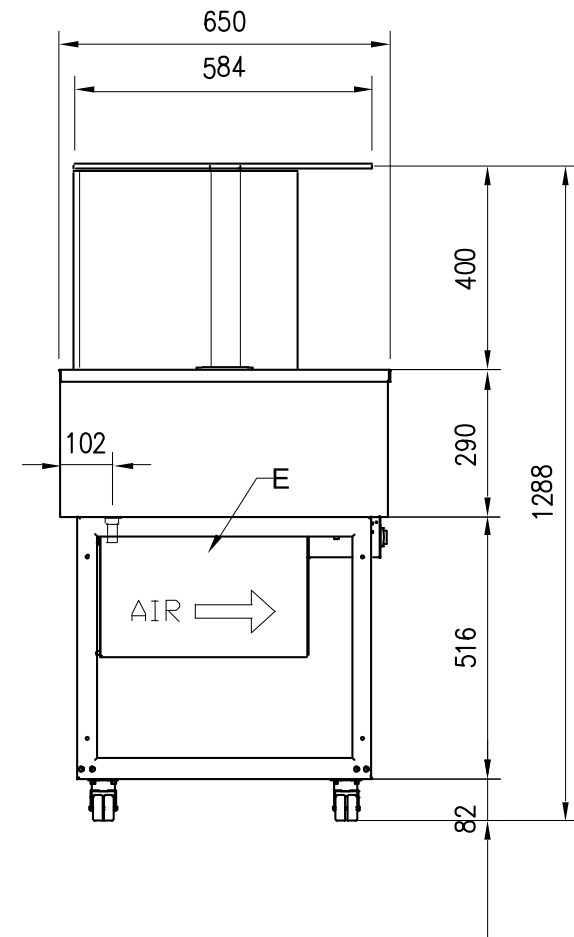

- A= ELECTRICAL CONNECTION
- D= WATER DISCHARGE $\varnothing 16$
- E= GAS CONNECTION $\varnothing 6 \varnothing 8$
- F= WATER BOX

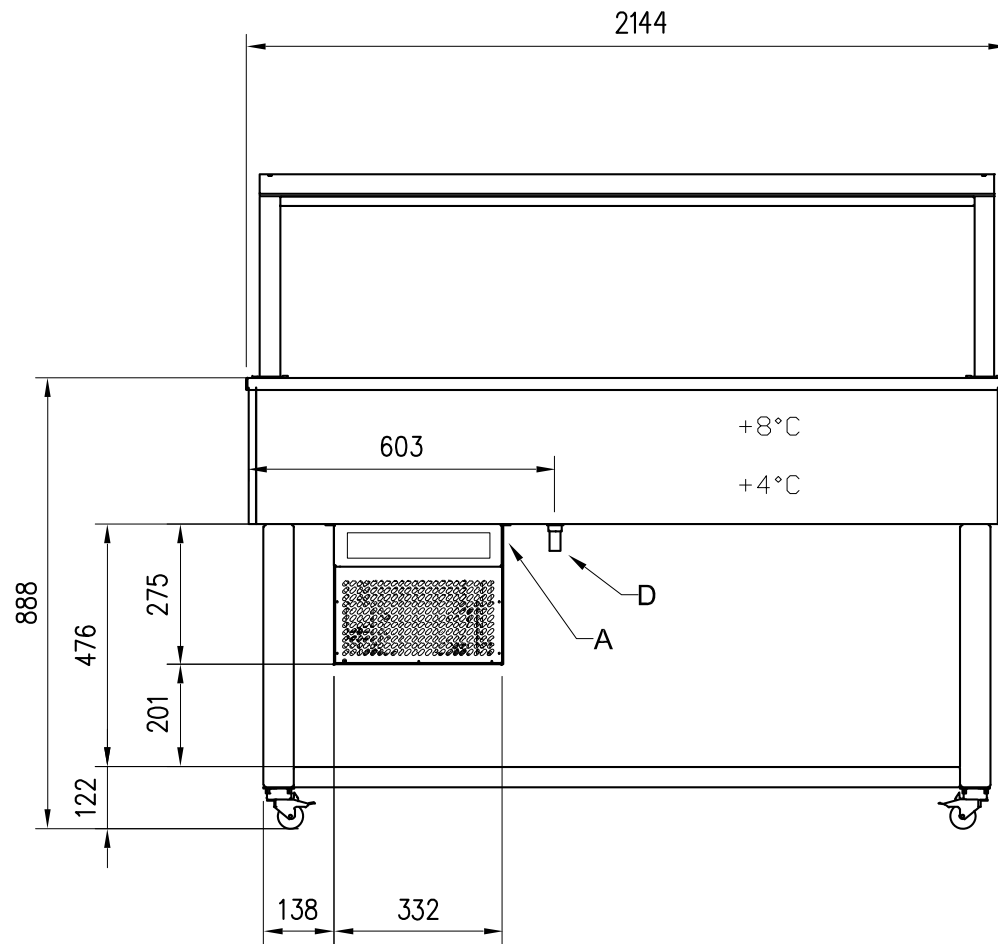