

Explosionszeichnung

COOL-LINE-Wandkühlregal CHAMONIX-T 100

[Art. 506030100]

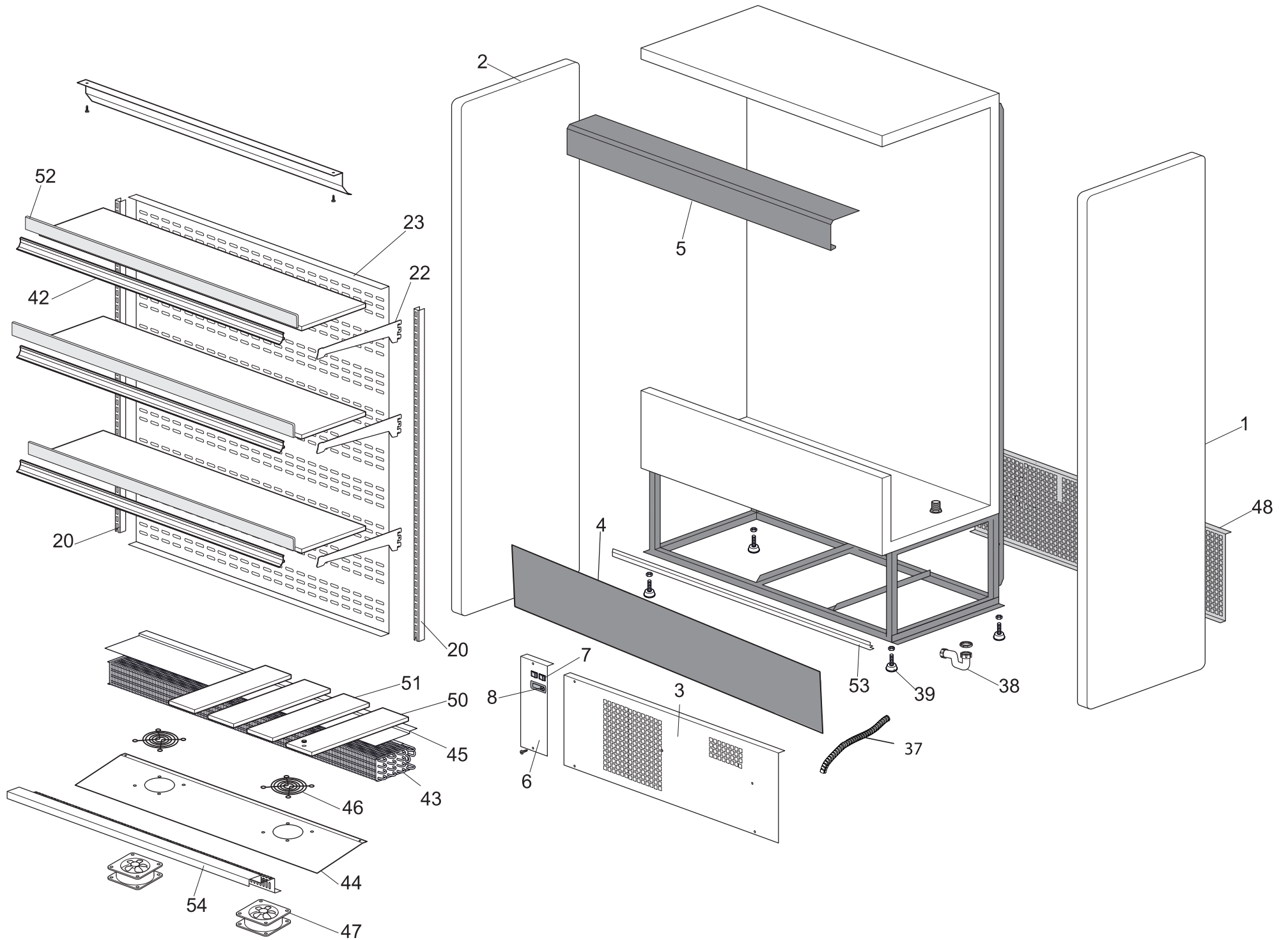



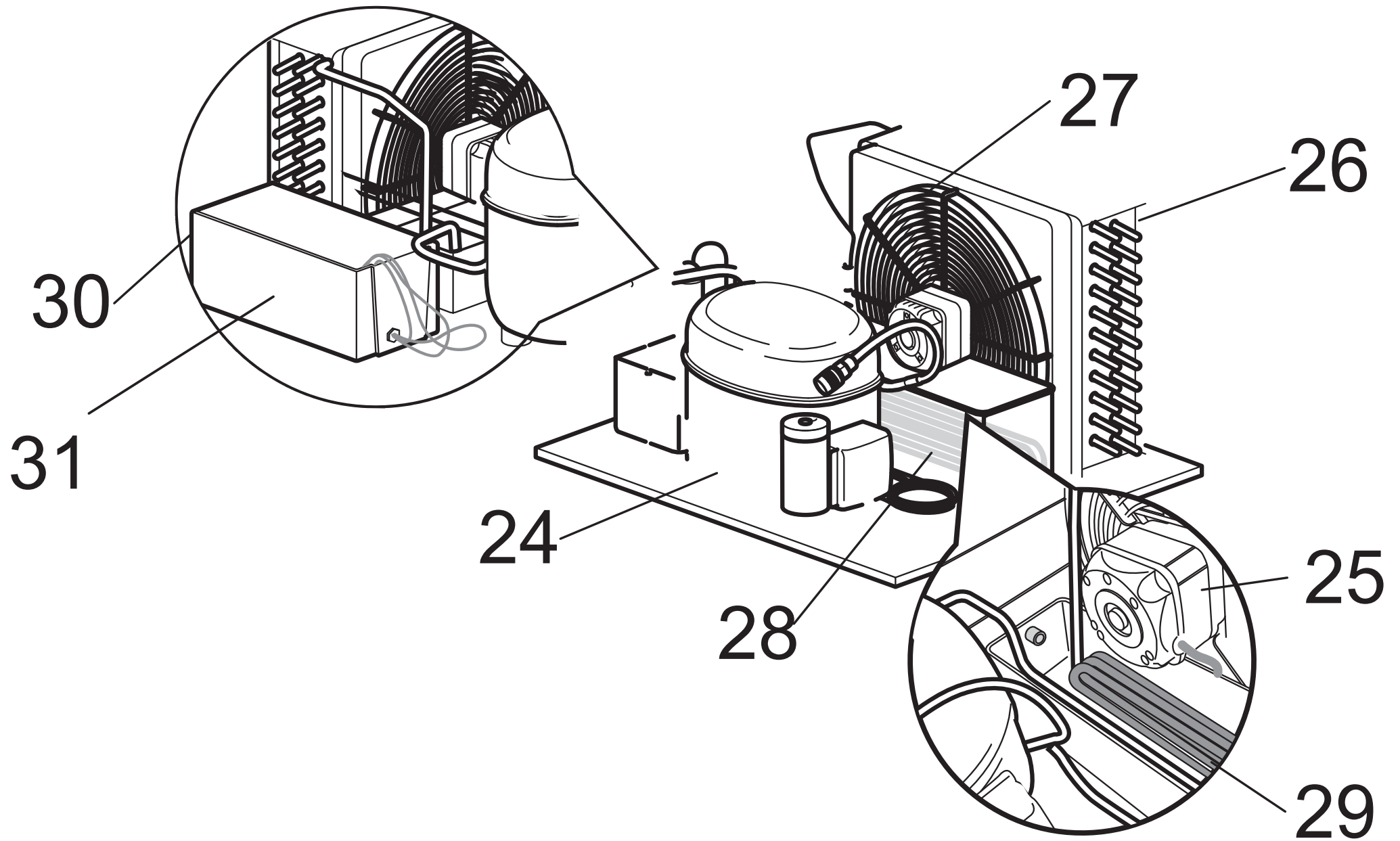

NordCap GmbH & Co. KG
Thalenhorststraße 15
28307 Bremen
Hauptsitz (Service, Finanzen & Personal, Lager, IT, Marketing)

Telefon: +49 421 48557-0
Telefax: +49 421 488650
E-Mail: bremen@nordcap.de

Die NordCap Verkaufsniederlassungen in Deutschland:

Nord: Hamburg • Ost: Berlin • Süd: Ingelheim • West: Erkrath

