

Ersatzteilliste-Explosionszeichnung

Neutralelement **AT9 / 800-GF-T**

[Art. 406392160]



**AMBIENT WORKTOP N900
NEUTRO N900**

PNC	Model	Ref	Brand	Page	Notes
391156	E9WTNBN000	a	Electrolux	2-4-5	WORKTOP 200 MM
391157	E9WTNBN00E	b	Electrolux	3-4-5	WORKTOP WITH 1 DRAWER 200 MM
391158	E9WTNDN000	c	Electrolux	2-4-5	WORKTOP 400 MM
391159	E9WTNDN00E	d	Electrolux	3-4-5	WORKTOP WITH 1 DRAWER 400 MM
391160	E9WTNHN000	e	Electrolux	2-4-5	WORKTOP 800 MM
391161	E9WTNHN00E	f	Electrolux	3-4-5	WORKTOP WITH 1 DRAWER 800 MM
391543	E9SSAGAOMAE	j	Electrolux	2-4-5	WORKTOP 200 MM 3 MM WORKTOP
391544	E9SSBGAOMAE	k	Electrolux	3-4-5	WORKTOP WITH 1 DRAWER 200 MM 3 MM WORKTOP
391545	E9SSAGAOMCE	u	Electrolux	2-4-5	WORKTOP 400 MM 3 MM WORKTOP
391546	E9SSBGAOMCE	v	Electrolux	3-4-5	WORKTOP WITH 1 DRAWER 400 MM 3 MM WORKTOP
391547	E9SSAGAOMEE	w	Electrolux	2-4-5	WORKTOP 800 MM 3 MM WORKTOP
391548	E9SSBGAOMEE	x	Electrolux	3-4-5	WORKTOP WITH 1 DRAWER 800 MM 3 MM WORKTOP
392156	Z9WTNBN000	g	Zanussi	2-4-5	WORKTOP 200 MM
392157	Z9WTNBN00E	h	Zanussi	3-4-5	WORKTOP WITH 1 DRAWER 200 MM
392158	Z9WTNDN000	i	Zanussi	2-4-5	WORKTOP 400 MM
392159	Z9WTNDN00E	l	Zanussi	3-4-5	WORKTOP WITH 1 DRAWER 400 MM
392160	Z9WTNHN000	m	Zanussi	2-4-5	WORKTOP 800 MM
392161	Z9WTNHN00E	n	Zanussi	3-4-5	WORKTOP WITH 1 DRAWER 800 MM
393156	A9WTNBN000	o	To brand	2-4-5	WORKTOP 200 MM
393157	A9WTNBN00E	p	To brand	3-4-5	WORKTOP WITH 1 DRAWER 200 MM
393158	A9WTNDN000	q	To brand	2-4-5	WORKTOP 400 MM
393159	A9WTNDN00E	r	To brand	3-4-5	WORKTOP WITH 1 DRAWER 400 MM
393160	A9WTNHN000	s	To brand	2-4-5	WORKTOP 800 MM
393161	A9WTNHN00E	t	To brand	3-4-5	WORKTOP WITH 1 DRAWER 800 MM

Index

Frame and components / Struttura e componenti
Spare parts list / Lista ricambi

Page

2-3
4

Bold=last change / Grassetto =ultima modifica

Rev. 2

From Ser. Nr. Up to Ser. Nr.	Ed. 2017-12 Updated 2020-07	Page: 1	Doc No:59785W200
---------------------------------	--------------------------------	---------	-------------------------

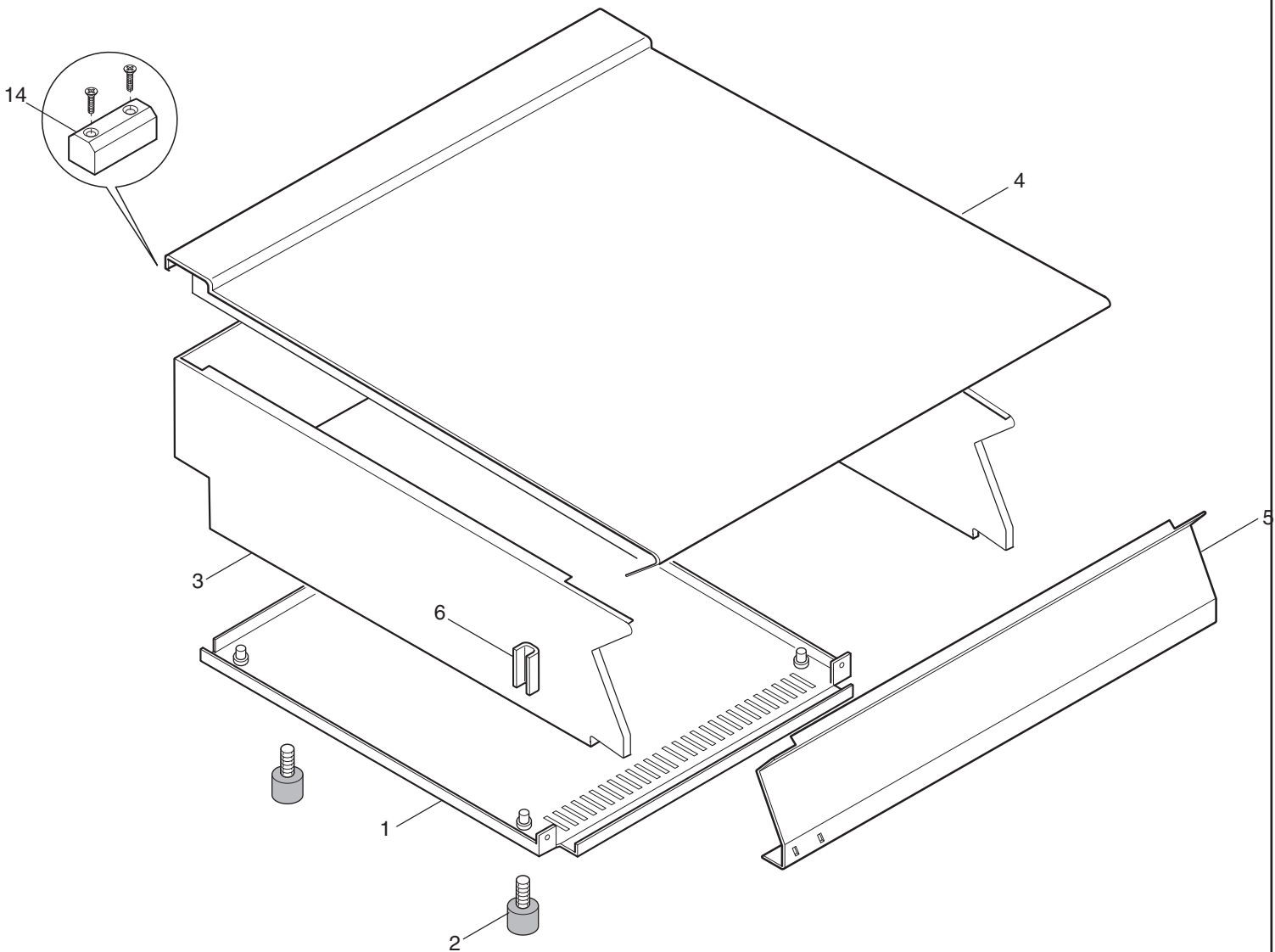

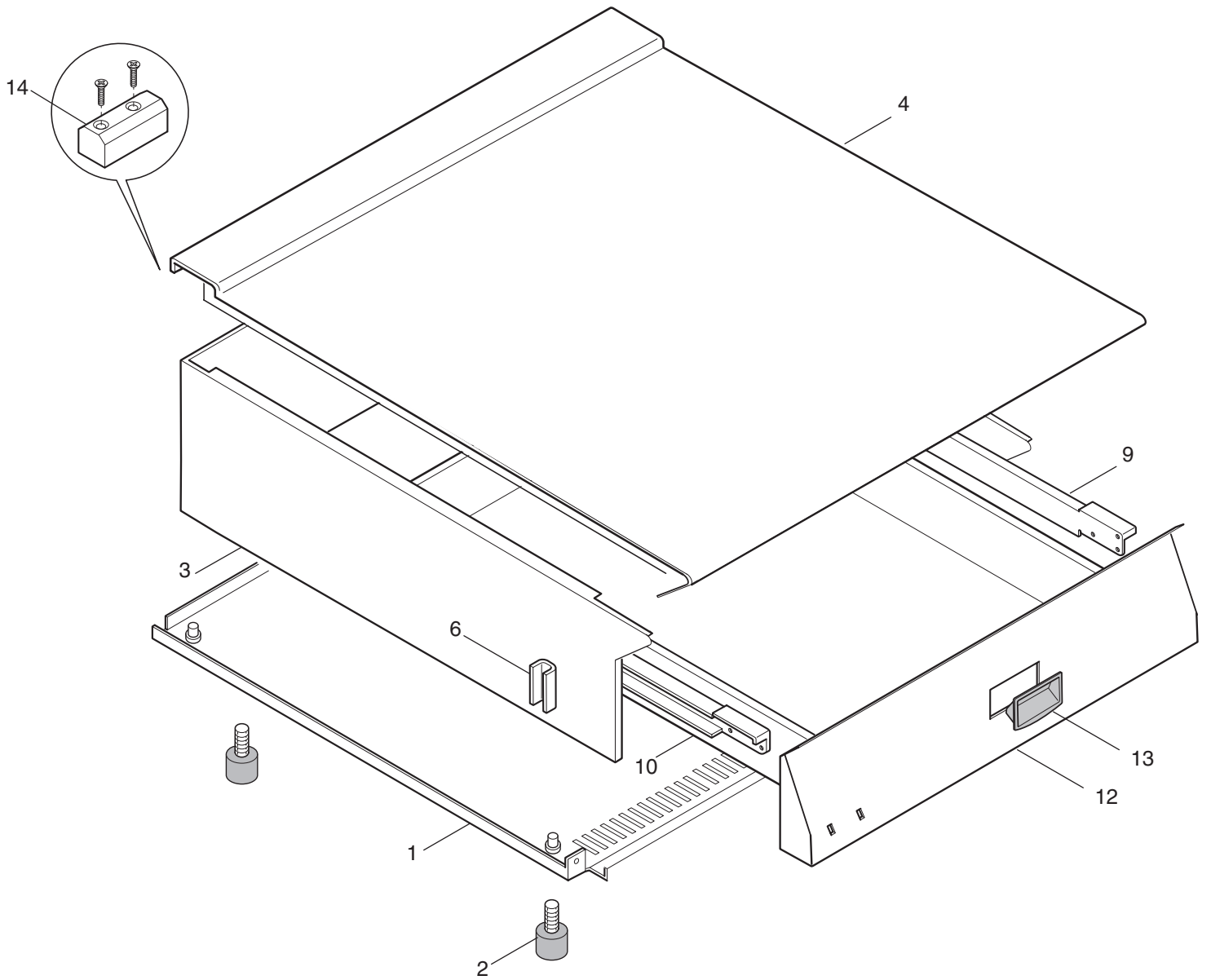

AMBIENT WORKTOP N900
NEUTRO N900

Pos	Factory Code	Spare Code	Descrizione	Description	Ref./Notes
1	0529851506	*	FONDO TOP 200 MM	BOTTOM TOP 200 MM	a g j o
1	0529851606	*	FONDO TOP 400 MM	BOTTOM TOP 400 MM	c i q u
1	0529851706	*	FONDO TOP 800 MM	BOTTOM TOP 800 MM	e m s w
1	050289AQ00	*	FONDO TOP CON CASSETTO 200MM	BOTTOM TOP WITH DRAWER 200 MM	b h k p
1	050289AR01	*	FONDO TOP CON CASSETTO 400MM	BOTTOM TOP WITH DRAWER 400 MM	d l r v
1	050289AS01	*	FONDO TOP CON CASSETTO 800 MM	BOTTOM TOP WITH DRAWER 800 MM	f n t x
2	0315252601	026806	PIEDINO	RUBBER FOOT	all
3	085089J701	*	RIVESTIMENTO LATERALE 200 MM	EXTERNAL PANEL 200MM	a j
3	050389NZ01	*	RIVESTIMENTO TOP + CASSETTO 200 MM	EXTERNAL PANEL TOP + DRAWER 200 MM	b k
3	085089DR02	0CA013	RIVESTIMENTO LATERALE 400MM	EXTERNAL PANEL 400MM	c u
3	050389NX03	*	RIVESTIMENTO TOP + CASSETTO 400 MM	EXTERNAL PANEL TOP + DRAWER 400 MM	d v
3	085089DS02	0C9625	RIVESTIMENTO LATERALE 800MM	EXTERNAL PANEL 800MM	e w
3	050389NV03	*	RIVESTIMENTO TOP + CASSETTO 800 MM	EXTERNAL PANEL TOP + DRAWER 800 MM	f x
3	085089J801	*	RIVESTIMENTO LATERALE 200 MM	EXTERNAL PANEL 200MM	g o
3	050389VK01	*	RIVESTIMENTO TOP + CASSETTO 200 MM	EXTERNAL PANEL TOP + DRAWER 200 MM	h p
3	085089DU02	*	RIVESTIMENTO LATERALE 400MM	EXTERNAL PANEL 400MM	i q
3	050389T202	*	RIVESTIMENTO TOP + CASSETTO 400 MM	EXTERNAL PANEL TOP + DRAWER 400 MM	l r
3	085089DV02	0C9937	RIVESTIMENTO LATERALE 800MM	EXTERNAL PANEL 800MM	m s
3	050389T302	*	RIVESTIMENTO TOP + CASSETTO 800 MM	EXTERNAL PANEL TOP + DRAWER 800 MM	n t
4	085089BA01	0C8621	RIPIANO NEUTRO 200MM	TABLE TOP 200MM	a b
4	085089BN02	0C7203	RIPIANO NEUTRO 400MM	TABLE TOP 400MM	c d
4	085089BL02	0C8622	RIPIANO NEUTRO 800MM	TABLE TOP 800MM	e f
4	085089GG01	*	RIPIANO NEUTRO 200MM	TABLE TOP 200MM	g h o p
4	085089GH03	0C7207	RIPIANO NEUTRO 400MM	TABLE TOP 400MM	i l q r
4	085089GJ03	*	RIPIANO NEUTRO 800MM	TABLE TOP 800MM	m n s t
4	087089SB00	*	RIPIANO NEUTRO 200MM 30/10	TABLE TOP 200MM 30/10	j k
4	087089SC00	*	RIPIANO NEUTRO 400MM 30/10	TABLE TOP 400MM 30/10	u v
4	087089SD00	*	RIPIANO NEUTRO 800MM 30/10	TABLE TOP 800MM 30/10	w x
5	050389NM01	0TTZA9	CRUSCOTTO NEUTRO 200	CONTROL PANEL 200	a g j o
5	085089BM02	0C7202	CRUSCOTTO NEUTRO + MARCHIATURA ELUX 400	CONTROL PANEL ELUX 400	c u
5	085089BK02	0C7818	CRUSCOTTO NEUTRO + MARCHIATURA ELUX 800	CONTROL PANEL ELUX 800	e w
5	085089G801	0C7206	CRUSCOTTO NEUTRO + MARCHIATURA ZAN 400	CONTROL PANEL ZAN 400	i
5	087089GP01	0C7611	CRUSCOTTO NEUTRO + MARCHIATURA ZAN 800	CONTROL PANEL ZAN 800	m
5	085089G702	0CA037	CRUSCOTTO NEUTRO + FORATURA 400	CONTROL PANEL 400	q
5	087089HS01	*	CRUSCOTTO NEUTRO + MARCHIATURA OEM 800	CONTROL PANEL OEM 800	s
6	0527850500	0C0156	PIASTRINA RINFORZO FIANCHI	SIDE PANEL JOINTING PALTE	a c e g i j m o q s u w
9+10	0835875Z00	0C7845	COPPIA GUIDE CASSETTO	DRAWER RUNNERS	b d f h k l n p r t v x
12	085089DJ00	*	CASSETTO 200MM	DRAWER 200 MM	b h k p
12	085089DK00	0C9841	CASSETTO 400MM	DRAWER 400 MM	d l r v
12	085089DL00	*	CASSETTO 800MM	DRAWER 800 MM	f n t x
13	051589A700	0C7164	MANIGLIA CASSETTO ELUX	DRAWER HANDLE ELUX	d f up to 02/2013
13	054887AH00	0C8769	MANIGLIA CASSETTO ELUX	DRAWER HANDLE ELUX	d f v from 03/2013
13	054887A802	0C8190	MANIGLIA CASSETTO ZAN	DRAWER HANDLE ZAN	l n
13	0548876R02	0C7175	MANIGLIA CASSETTO OEM	DRAWER HANDLE OEM	r t
14	0516860700	0C0137	PIASTRINA DI UNIONE	JOINTING REAR PLATE	all



Electrolux Professional SPA
Viale Treviso 15
33170 Pordenone
www.electrolux-professional.com

NordCap GmbH & Co. KG
Thalendorststraße 15
28307 Bremen
Hauptsitz (Service, Finanzen & Personal, Lager, IT, Marketing)

Telefon: +49 421 48557-0
Telefax: +49 421 488650
E-Mail: bremen@nordcap.de

Die NordCap Verkaufsniederlassungen in Deutschland:

Nord: Hamburg • Ost: Berlin • Süd: Ingelheim • West: Erkrath

by **NordCap**[®]

ZANUSSI
PROFESSIONAL