

# Masszeichnung

## Neutralelement EVO 700 NE7 / 400T

[Art. 406372116]

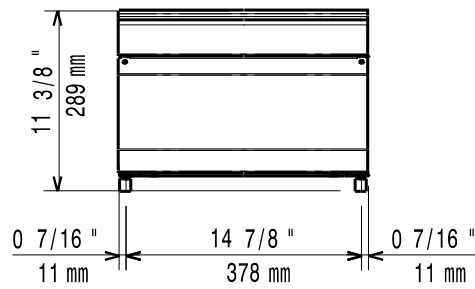

[Vorderansicht]

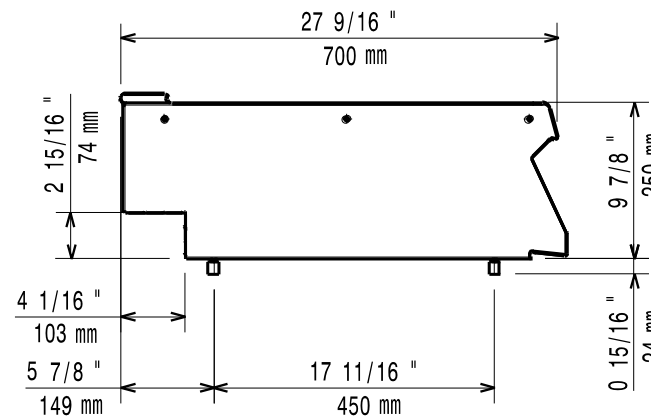

[Seitenansicht]

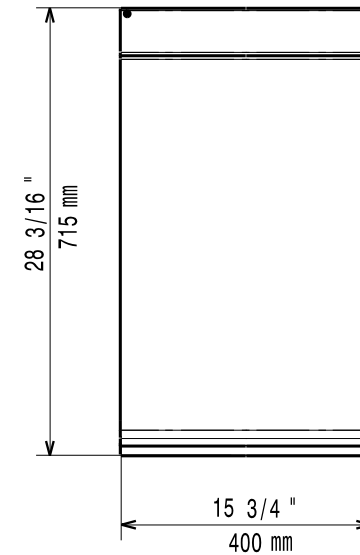

[Draufsicht]