

Ersatzteilliste-Explosionszeichnung

Konditoreitheke **FLANTASTIC GREEN L GS-132-69-E**

[Art. 484357411]



Licht und Rahmenheizung können bei Sondergeräten entfallen.
Lighting and frame heating could be omitted at custom units.

Kühlvitrienen – steckerfertig, ohne Nachlaufrelais für Kondensatorlüfter
Refrigerated display cases – self-contained, without time-delay relay for condenser fans

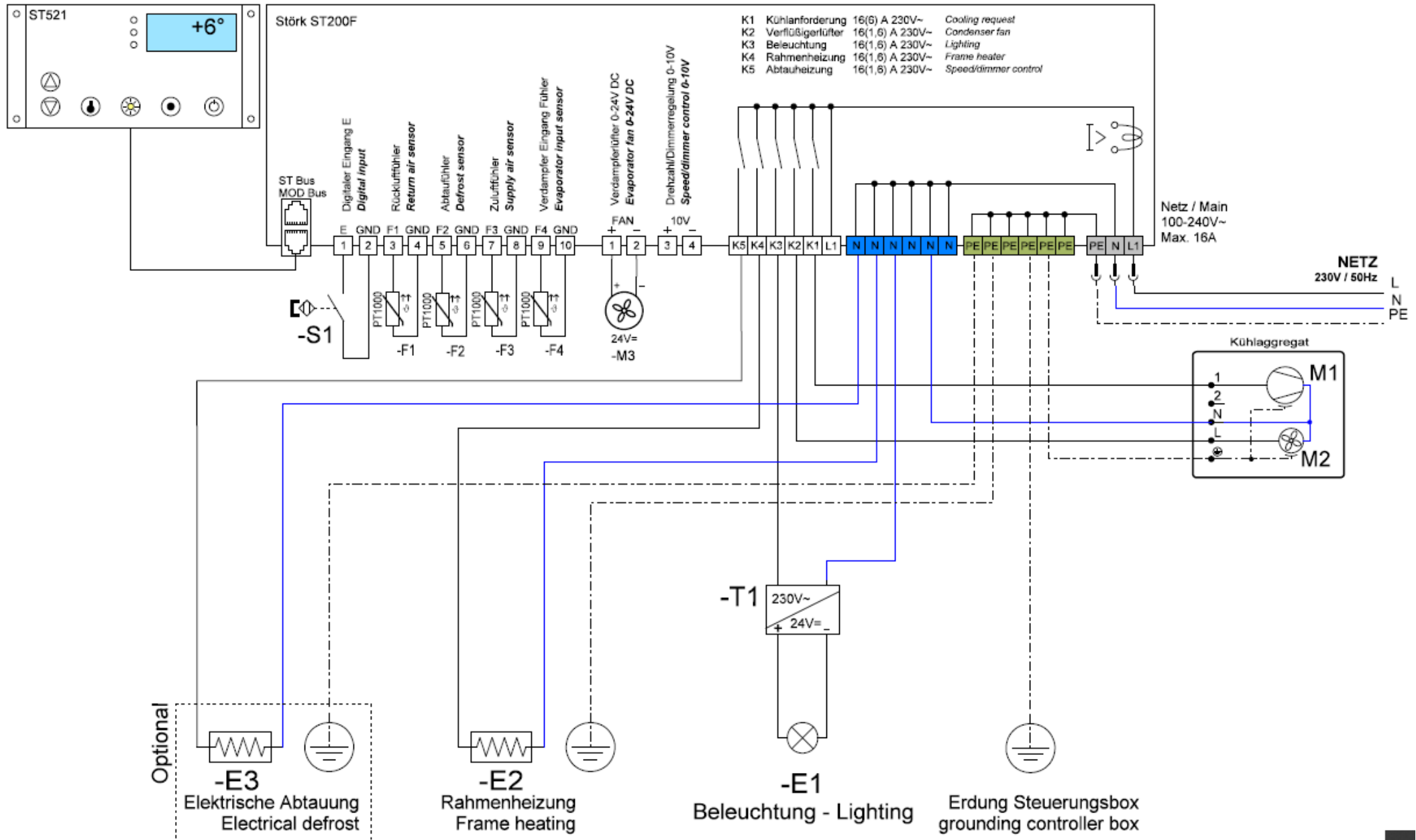

Vernetzung / Networking

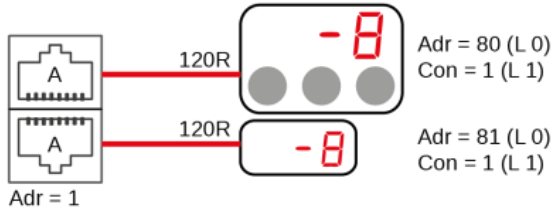
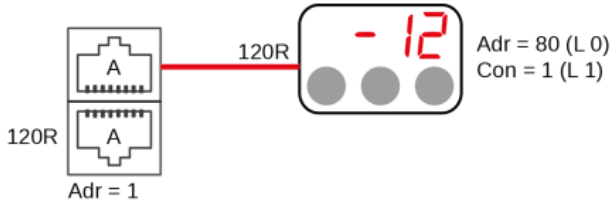

1x RS485 (A)

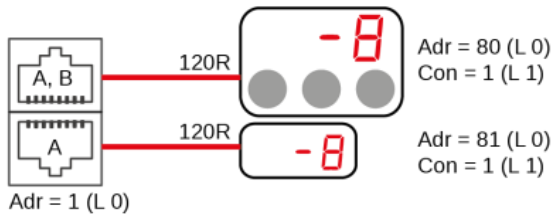
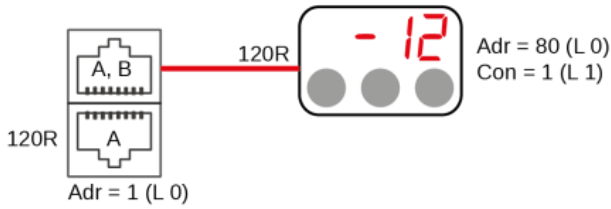

2x RS485 (A, B)

