

Schaltplan

Kälteaggregat TYP 2 HEG

[Artikel-Nr.: 46710802002-G-F-0]

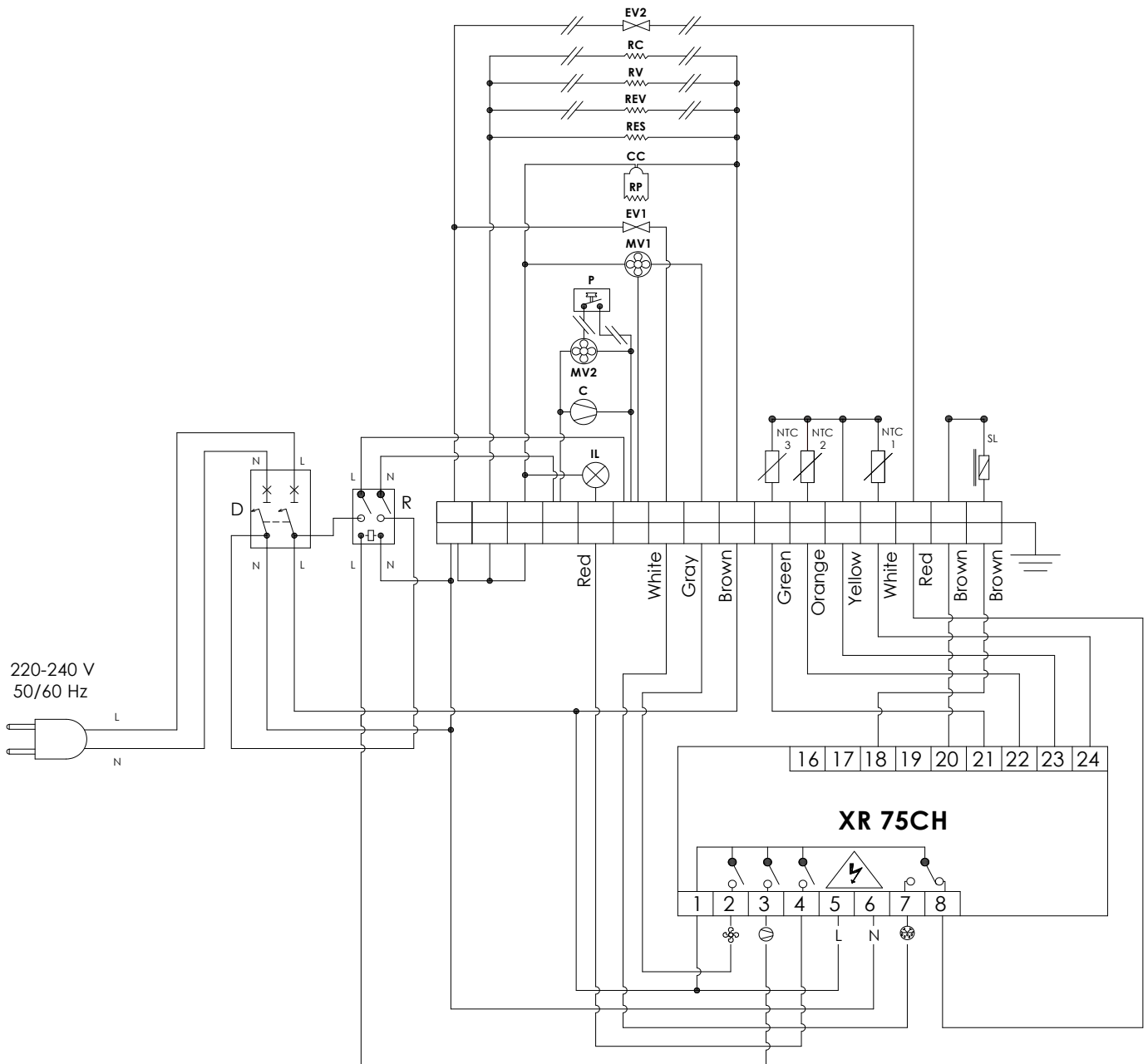



(PT) LEGENDA

C	Compressor
CC	Conector
D	Disjuntor
EV1	Electroválvula
EV2	Eletroválvula Sanhua
IL	Iluminação
MV1	Ventilador do evaporador
MV2	Ventilador do condensador
NTC1	Sonda ambiente
NTC2	Sonda evaporador
NTC3	Sonda do condensador
P	Pressostato
R	Relé
RP	Resistência da porta
RES	Resistência do Esgoto
REV	Resistência de Evaporação
RV	Resistência Válvula de Compensação
RC	Resistência do Compressor
SL	Sensor de Luz

(IT) LEGENDA

Compressore
Connettore
Interruttore (RCD)
Valvola Elettrica
Valvola Elettrica Sanhua
Illuminazione
Ventilatore dell'evaporatore
Ventilatore del condensatore
Sonda ambiente
Sonda dell' evaporatore
Sonda del condensatore
Pressostato
Relé
Resistenza della porta
Resistenza di Scarico
Evaporazione Rsistenza
Resistenza Valvola di Compensazione
Resistenza di Compressore
Sensore di luce

(ES) LEYENDA

Compresor
Conector
Disjuntor
Electrovalvula
Electroválvula Sanhua
Iluminación
Ventilador del evaporador
Ventilador del condensador
Sonda ambiente
Sonda del evaporador
Sonda del condensador
Pressostato
Relé
Resistencia de la puerta
Resistencia de Desague
Evaporación Resistencia
Resistencia de valvula de Compensación
Resistencia de Compresor
Sensor de luz

(EN) LEGEND

C	Compressor
CC	Connector
D	Circuit Breaker
EV1	Electric valve
EV2	Electricvalve Sanhua
IL	Lighting
MV1	Evaporator fan
MV2	Condenser fan
NTC1	Ambient probe
NTC2	Evaporator probe
NTC3	Condenser probe
P	Pressure Switch
R	Relay
RP	Door heated cord
RES	Drain Resistance
REV	Evaporation Resistance
RV	Compensation Valve Resistance
RC	Compressor Resistance
SL	Light Sensor

(FR) LÉGENDE

Compresseur
Connecteur
Disjoncteur
Soupape Électrique
Soupape Sanhua
L'Éclairage
Ventilateur de l'évaporateur
Ventilateur du condenseur
Sonde environnement
Sonde de l'évaporateur
Sonde du condenseur
Pressostat
Relais
Résistance de la porte
Résistance d' Égout
Resistance Evaporation
Resistance soupape de Compensation
Resistance du Compresseur
Senseur de lumière

(DE) BILDERKLÄRUNG

Kompressor
Stecker
Leistungsschalter
Elektrisches Ventil
Elektrisches Ventil Sanhua
Beleuchtung
Verdampferlüfter
Kondensatorlüfter
Umgebungssonder
Verdampferfühler
Kondensatorfühler
Druckschalter
Relais
Türrahmenheizung
Widerstand des Abflusses
Evaporation Widerstand
Widerstand Ausgleichsventil
Widerstand des Kompressor
Lichtsensor

Finanzen/Service

28307 Bremen
Thalenhorststraße 15
Tel.+49 421 48557-0
Fax+49 421 488650
bremen@nordcap.de

Vertrieb Ost

12681 Berlin
Wolfener Straße 32/34, Haus K
Tel.+49 30 936684-0
Fax+49 30 936684-44
berlin@nordcap.de

Vertrieb West

40699 Erkrath
Max-Planck-Straße 30
Tel.+49 211 540054-0
Fax+49 211 540054-54
erkrath@nordcap.de

Vertrieb Nord

21079 Hamburg
Großmoorbogen 5
Tel.+49 40 766183-0
Fax+49 40 770799
hamburg@nordcap.de

Vertrieb Süd

55218 Ingelheim
Hermann-Bopp-Straße 4
Tel.+49 6132 7101-0
Fax+49 6132 7101-20
ingelheim@nordcap.de

