

Ersatzteilliste-Explosionszeichnung

Tiefkühltsch

CLM-TK 700 3-7011

[Art. 402712201]



**HORIZONTAL COUNTERS
TAVOLI ORIZZONTALI**

**ECOSTORE HP & CL h700
Left side cooling unit**

Type reference	Ref	Page	Description	Brand
H7NTN2BHC	a	3 to 13	Counter 2 compartments refrigerated HP	all
H7NTN3BHC	b	3 to 13	Counter 3 compartments refrigerated HP	all
H7NTN4BHC	c	3 to 13	Counter 4 compartments refrigerated HP	all
H7NBT2BHC	d	3 to 14	Counter 2 compartments freezer HP&CL	all
H7NBT3BHC	e	3 to 14	Counter 3 compartments freezer HP&CL	all
H7NBT2B	f	3 to 14	Counter 2 compartments freezer CL	all
H7NBT3B	g	3 to 14	Counter 3 compartments freezer CL	all

Note :

page 13 control panel HP range

page 12 control panel CL range

Index

	Page
Identification Type Ref./Identificazione type Ref.	2
Body module/corpo armadio	3
Spare part list/Lista ricambi	4
Door and drawers/ Porte e cassetti	5,6,7
Spare part list/Lista ricambi	8
Top/Ripiano	9
Spare part list/Lista ricambi	10
Cooling unit Refrig. & Freezer/Gruppo Refrigerato & Freezer R290&R404a	11
Spare part list/Lista ricambi	12
Control panel/Pannello di controllo HP	13
Control panel/Pannello di controllo CL	14
Spare part list/Lista ricambi	15

...Bold= last change/Grassetto =ultima modifica

How to put in relation the “Type Ref.” reported on the data plate with the “Type reference” reported on the front page of the Spare Part Catalogue:

The “Type Ref.” represents a group of models/brands all with similar technical features, hence possible to be reported under the same scheme in terms of exploded views.

Find below an identification example: **H7NTN2BHC**

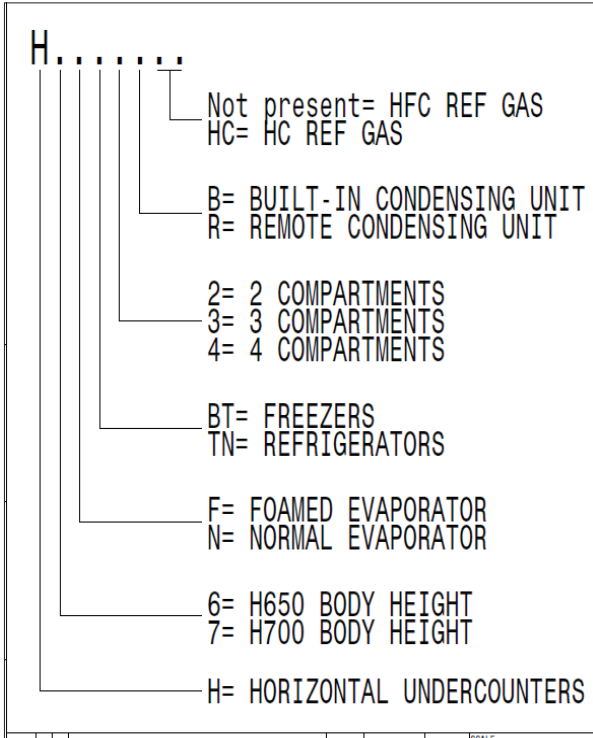

F. Mod. EH2H7AA	Comm. Mod. EH2H7AA	Type Ref. H7NTN2BHC	2017
PNC 9VTX 710000 00	Ser. No. 70810001	Cyclopentane	
W Tot. 0.25 kW	Volt 220-240 V	1 ~ 50 Hz	Total Current 1.9 A
Potenza Sbrinamento / Defrost Power	0.29 kW	Classe/Class 5	GWP 3 CO2-eq 0 t
Resistenza Evaporazione/Evaporation Heater El.	kW	Refrigerante / Refrigerant R290	0,07 kg.
Illuminazione / Lighting	W	Cap. 240	MADE IN ITALY
NF nominal Charge			
Rated Pressure	MPa		
IP21			
Electrolux Professional SpA - Viale Treviso, 15 - 33170 Pordenone (Italy)			

For the right spare code identification follow the steps:

1. type in the website the PNC reported on the data plate.
2. The website will automatically display this spare part catalogue.
3. The spare part code at this point is referenced through the “Type reference” as from the front page by the relevant “Ref”.

Come mettere in relazione il “Type Ref.” Riportato sulla targhetta caratteristica con il “Type reference” riportato sul frontespizio del catalogo ricambi:

Il “Type Ref.” Rappresenta un gruppo di modelli/marchi con simili caratteristiche tecniche, ossia possibili da rappresentare con il medesimo schema in termini di vista esplosa.

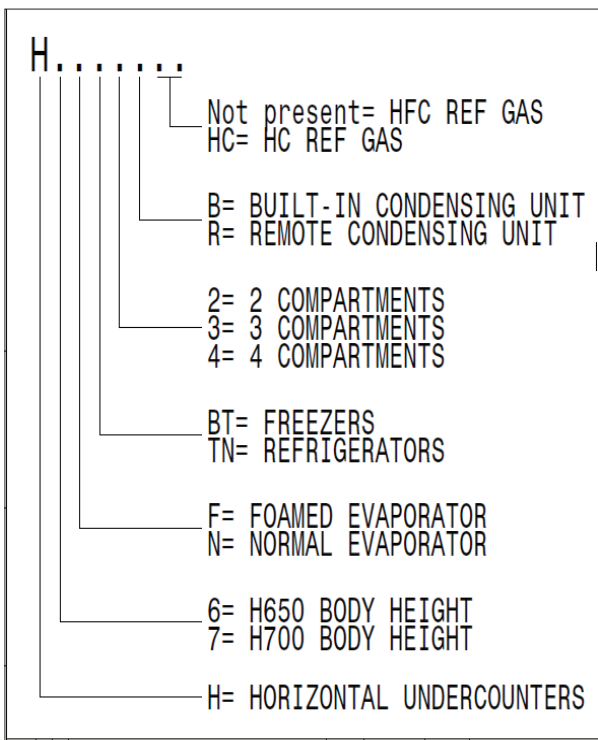

Qui di seguito un esempio di identificazione: **H7NTN2BHC**

F. Mod. EH2H7AA	Comm. Mod. EH2H7AA	Type Ref. H7NTN2BHC	2017
PNC 9VTX 710000 00	Ser. No. 70810001	Cyclopentane	
W Tot. 0.25 kW	Volt 220-240 V	1 ~ 50 Hz	Total Current 1.9 A
Potenza Sbrinamento / Defrost Power	0.29 kW	Classe/Class 5	GWP 3 CO2-eq 0 t
Resistenza Evaporazione/Evaporation Heater El.	kW	Refrigerante / Refrigerant R290	0,07 kg.
Illuminazione / Lighting	W	Cap. 240	MADE IN ITALY
NF nominal Charge			
Rated Pressure	MPa		
IP21			
Electrolux Professional SpA - Viale Treviso, 15 - 33170 Pordenone (Italy)			

Per identificare il corretto codice ricambio procedere con:

1. Digitare nel website il PNC riportato sulla targhetta caratteristica.
2. Il website mostrerà automaticamente questo catalogo ricambi.
3. A questo punto, il codice ricambio è identificabile attraverso il “Type reference” come indicato nel frontespizio sotto la relativa voce “Ref”.

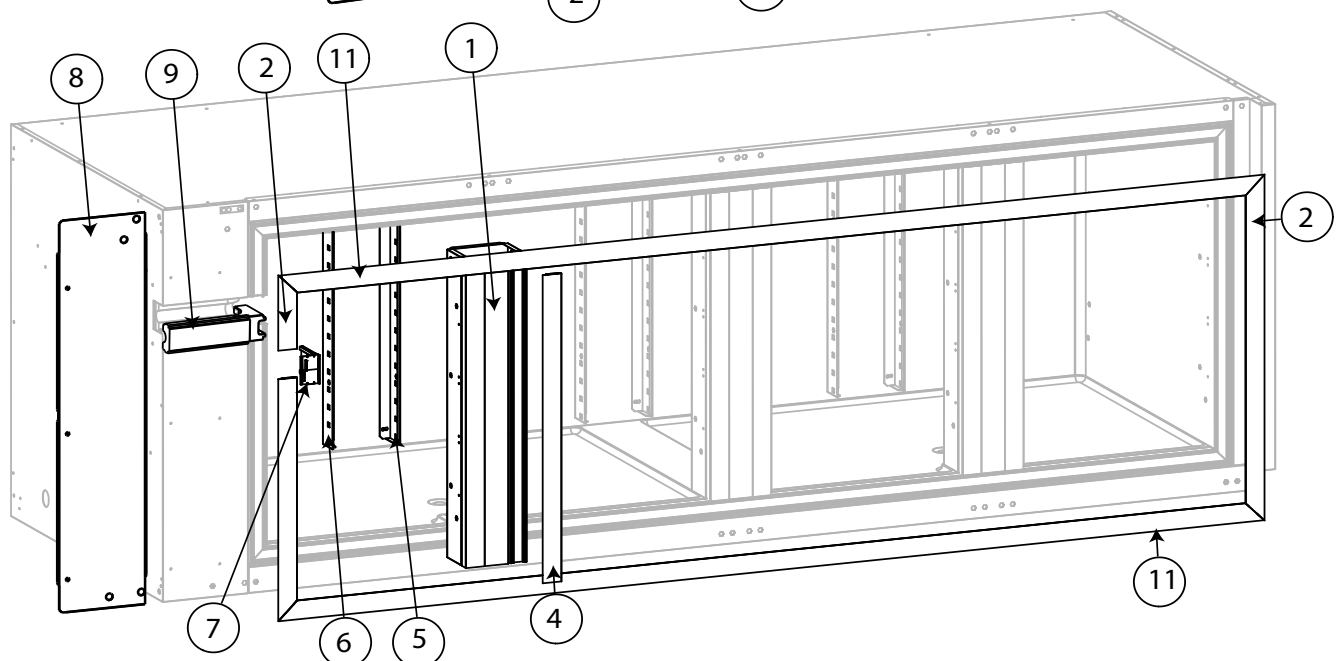
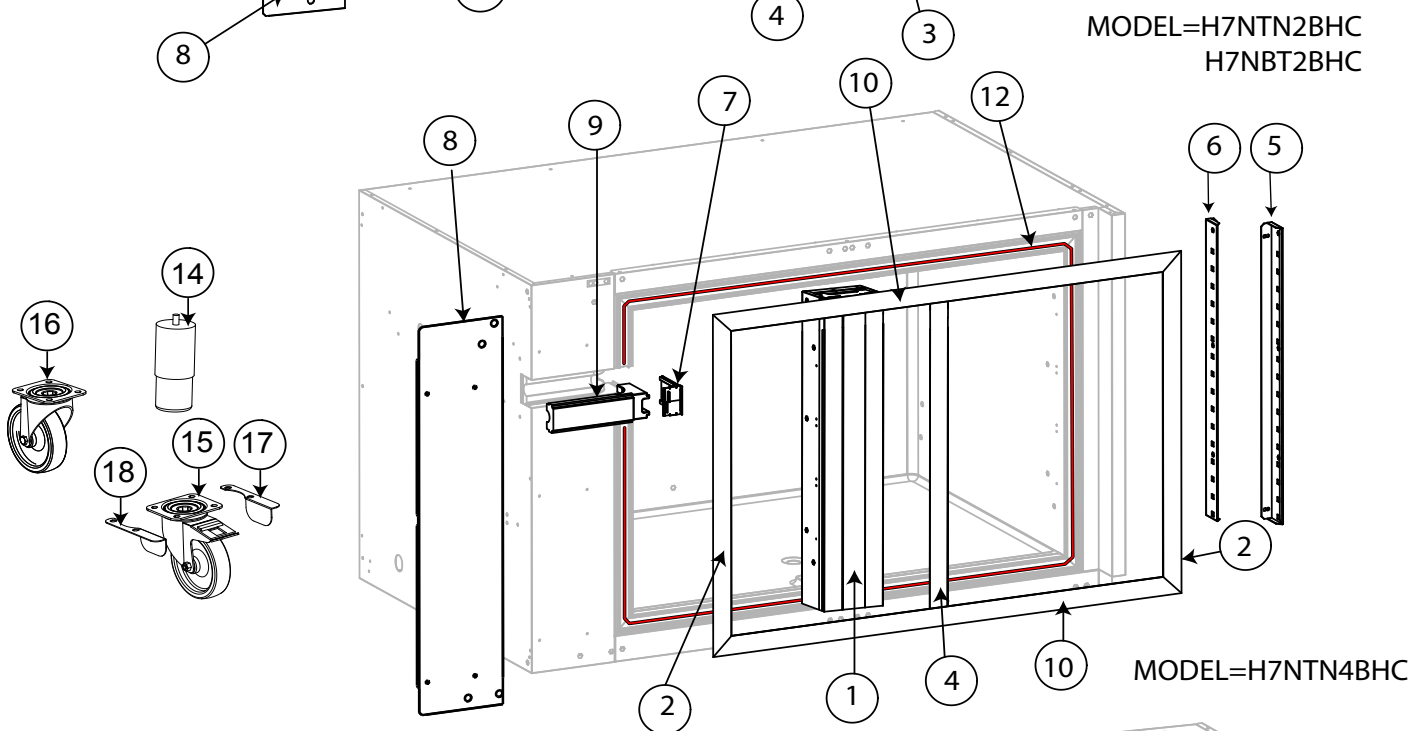
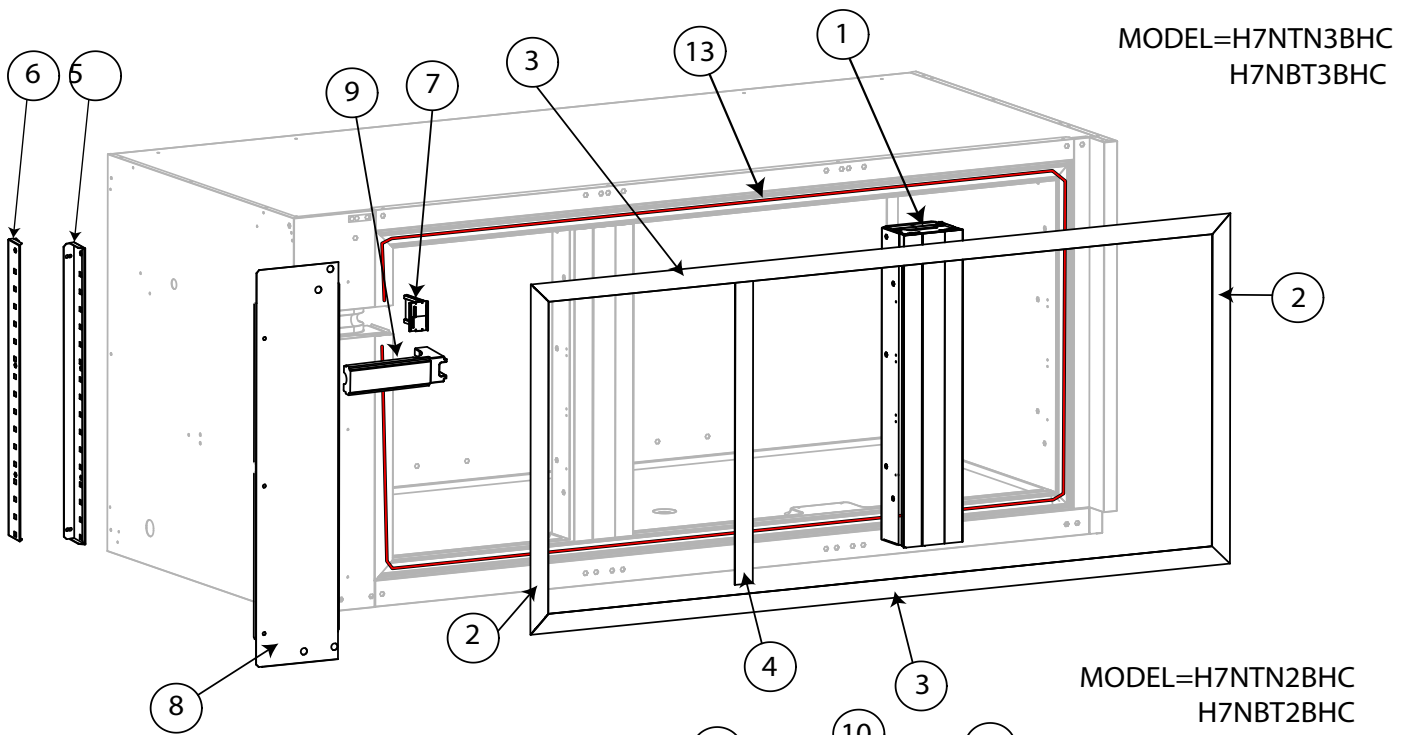

Pos	Code	Factory code	Description	Descrizione	Ref/notes
Reference pag.3					
Body Assembly			Corpo schiumato		
1	095337	835R54002	FOAMED VERTICAL PILLAR ASSEMBLED	MONTANTE ASSEMBLATO	a,b,c up to 9131
1	096522	835R67901	FOAMED VERTICAL PILLAR ASSEMBLED	MONTANTE ASSEMBLATO	a,b,c from 9141 d,e,f,g from 9391
1	095345	835R56401	FOAMED VERTICAL PILLAR ASSEMBLED	MONTANTE ASSEMBLATO	d,e,f,g up to 9131
1		835R68101	FOAMED VERTICAL PILLAR ASSEMBLED	MONTANTE ASSEMBLATO	d,e,f,g from 9141 up to 9381
2	095236	543R16400	VERTICAL FRAME COVER	COPERCHIO CORN.VERT. TAV 2/3/4V	a,b,c
2	095346	543R19801	VERTICAL FRAME COVER	COPERCHIO CORN.VERT. TAV 2V BT	d,e,f,g
3	095246	543R16600	HORIZONTAL FRAME COVER <u>refriger.</u>	COPERCHIO CORN ORIZZ TAV 3V TN	b
3	095253	543R19500	HORIZONTAL FRAME COVER <u>freezer</u>	COPERCHIO CORN ORIZZ TAV 3V BT	e,g
4	095338	543R17701	VERTICAL FRAME FOR PILLAR	CORNICE VERTICALE MONTANTE	a,b,c
4	095347	543R19700	VERTICAL FRAME FOR PILLAR	CORNICE VERTICALE MONTANTE	d,e,f,g
5	095321	503R16704	REAR RIGHT SUPPORT GRIDS H700	SUPPORTO POSTERIORE DX	
6	095322	502R84504	REAR LEFT SUPPORT GRIDS H700	SUPPORTO POSTERIORE SX	
7	095323	543R17804	HEAT EXCHANGER HOUSING SIDE	COPERTURA TUBI SCAMBIATORE	
8	095358	503R40601	FRONT COVER PANEL SIDE (LEFT)	PANNELLO FRONTALE SX A304	
9	095225	569R09502	INSULATION BLOCK HEAT EXCH.	ISOLAMENTO PER TUBI SCAMBIATO.	
10	095226	543R16500	HORIZONTAL FRAME COVER	COPERCHIO CORN ORIZZ TAV 2V	a
10	095254	543R19400	HORIZONTAL FRAME COVER	COPERCHIO CORN ORIZZ TAV 2V	d,f
11	095255	543R16700	HORIZONTAL FRAME COVER	COPERCHIO CORN ORIZZ TAV 4V	c
12	093330	617R06701	FRAME HEATING CABLE 2V L 5450 mm	CAVO RISCALDANTE CORNICI 2V porte	d,f only door
12	095256	617R15600	FRAME HEATING CABLE 2V L 6700 mm	CAVO RISCALDANTE CORNICI 2V	d,f 1 door_2 1/2 draw.
12	095257	617R15900	FRAME HEATING CABLE 2V L 9140 mm	CAVO RISCALDANTE CORNICI 2V	d,f 6 1/3 draw.
12	095258	617R15700	FRAME HEATING CABLE 2V L 8320 mm	CAVO RISCALDANTE CORNICI 2V	d,f 2 1/2 draw_3 1/3 drawers
12	095259	617R15800	FRAME HEATING CABLE 2V L 7490 mm	CAVO RISCALDANTE CORNICI 2V	d,f 4 1/2 draw. 1Door_3 1/3 drawers
13	094096	617R09500	FRAME HEATING CABLE 3V L 8140 mm	CAVO RISCALDANTE CORNICI 3V	e,g only door
13	095260	617R16000	FRAME HEATING CABLE 3V L 8600 mm	CAVO RISCALDANTE CORNICI 3V	e,g 2 door_2 1/2 draw.
13	095261	617R16100	FRAME HEATING CABLE 3V L 9400 mm	CAVO RISCALDANTE CORNICI 3V	e,g 1 door_4 1/2 draw. 2 door_3 1/3 draw.
13	095262	617R16200	FRAME HEATING CABLE 3V L 10200 mm	CAVO RISCALDANTE CORNICI 3V	e,g 6 1/2 draw. 1 door_2 1/2 draw_3 1/3 dw.
13	095263	617R16300	FRAME HEATING CABLE 3V L12700 mm	CAVO RISCALDANTE CORNICI 3V	e,g 9 1/3 draw.
13	095264	617R16400	FRAME HEATING CABLE 3V L11030 mm	CAVO RISCALDANTE CORNICI 3V	e,g 1 door_6 1/3 draw. 4 1/2 draw_3 1/3 drawers
13	095265	617R16500	FRAME HEATING CABLE 3V L11850 mm	CAVO RISCALDANTE CORNICI 3V	e,g 2 1/2 draw_6 1/3 drawers
14	091610	0518R01100	FOOT H 150 WITH CENTRAL SCREW	PIEDE VITE CENT.+ RIVEST.INOX H150	
15	087110	0835739900	WHEEL WITH BRAKE H155	RUOTA A PIASTRA ROT. CON FRENO	H = 155
15	095544	518R08700	WHEEL WITH BRAKE H100	RUOTA A PIASTRA ROT. CON FRENO	H = 100
16	087111	0835740000	WHEEL WITH-OUT BRAKE H155	RUOTA A PIASTRA ROT. NO FRENO	H = 155
16	095545	518R08800	WHEEL WITH-OUT BRAKE H100	RUOTA A PIASTRA ROT. NO FRENO	H = 100
17	095324	0503R38502	RIGHT WHEEL LEVER BRAKE	FERMO RUOTA DESTRO	
18	095325	0503R38602	LEFT WHEEL LEVER BRAKE	FERMO RUOTA SINISTRO	
19					

881R40103
881R57901
881R75100
881R75000

APX/ZAN H700 DOOR

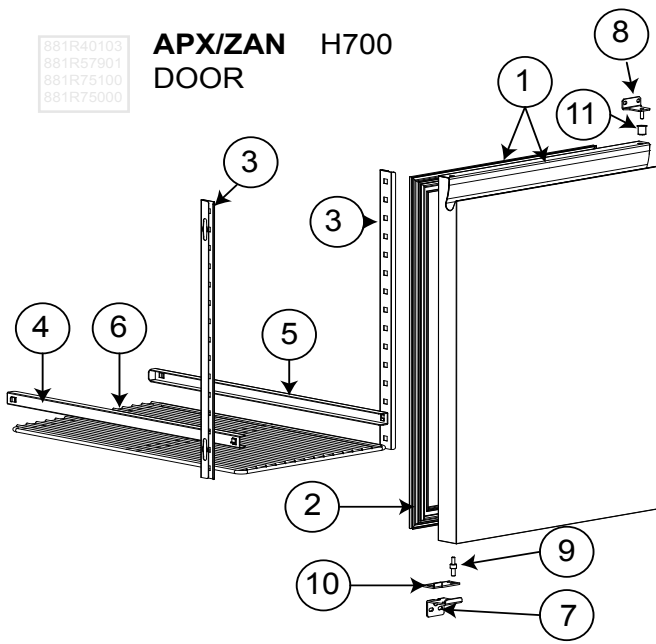

881R53002
881R74500
881R57600
881R74400

ELUX H700 DOOR

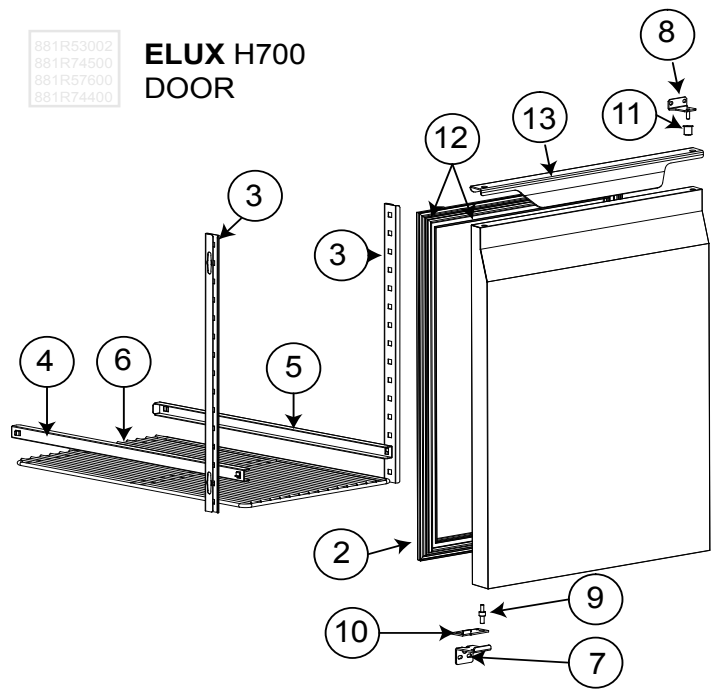

881R57701
881R77600

APX/ZAN H700 DRAW 1/3

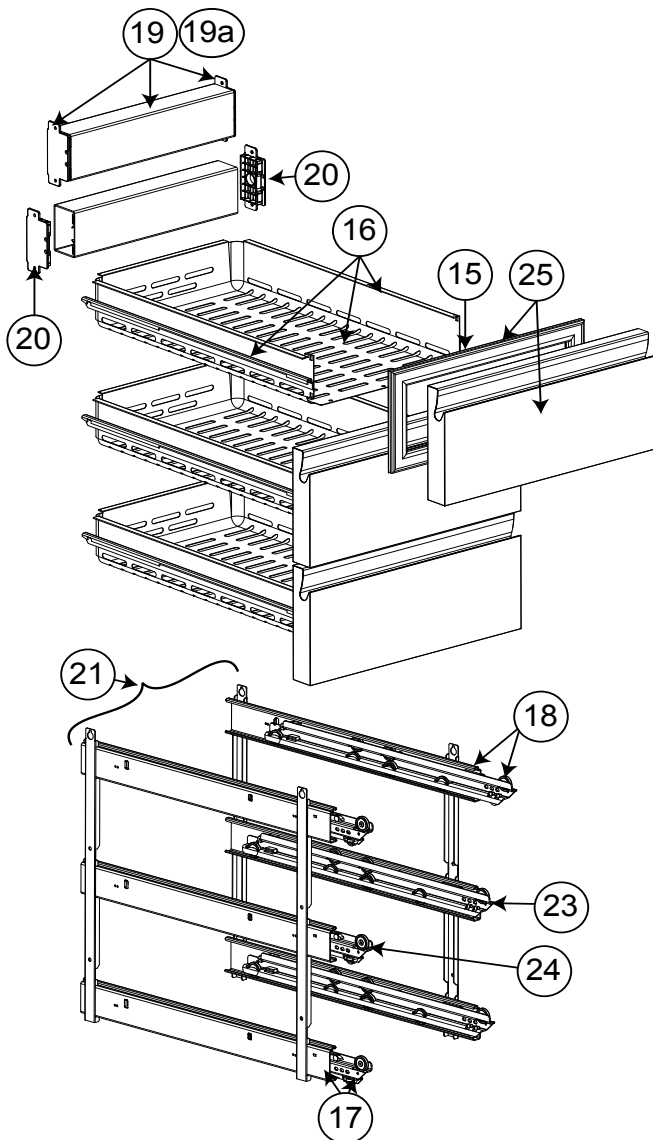

881R57001
881R77700

ELUX H700 DRAW. 1/3

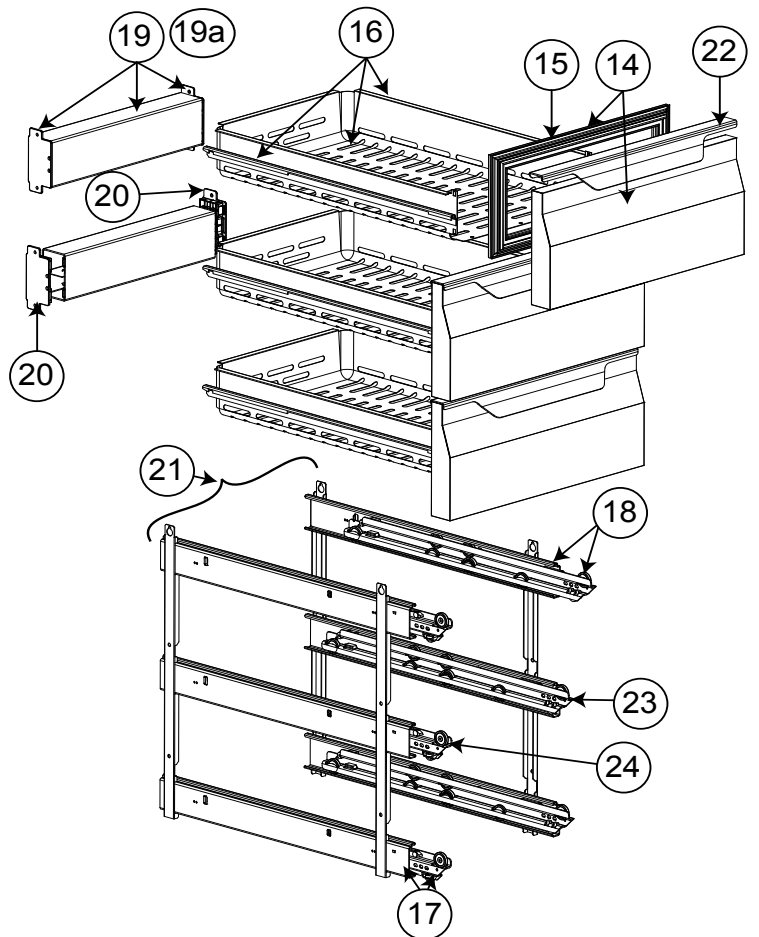

ELUX H700
DRAW. 1/2

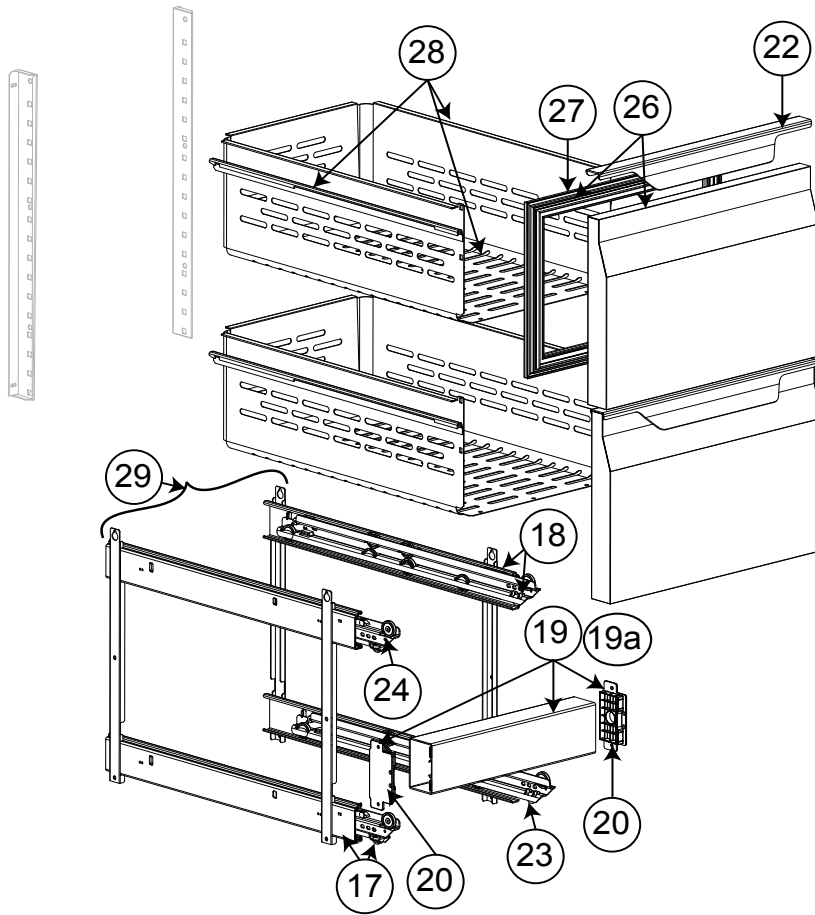

881R57501
881R77500

APX/ZAN H700
DRAW.1/2

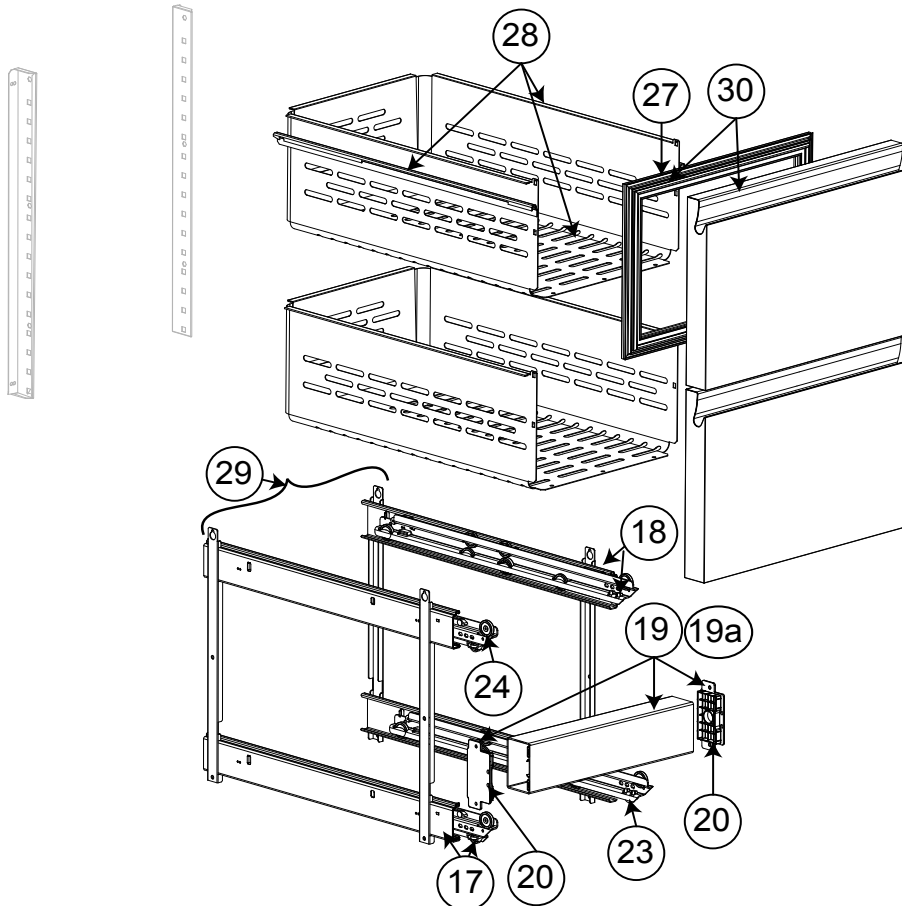

881R57801
881R77600

ELUX H700
BOTTLE DRAW.

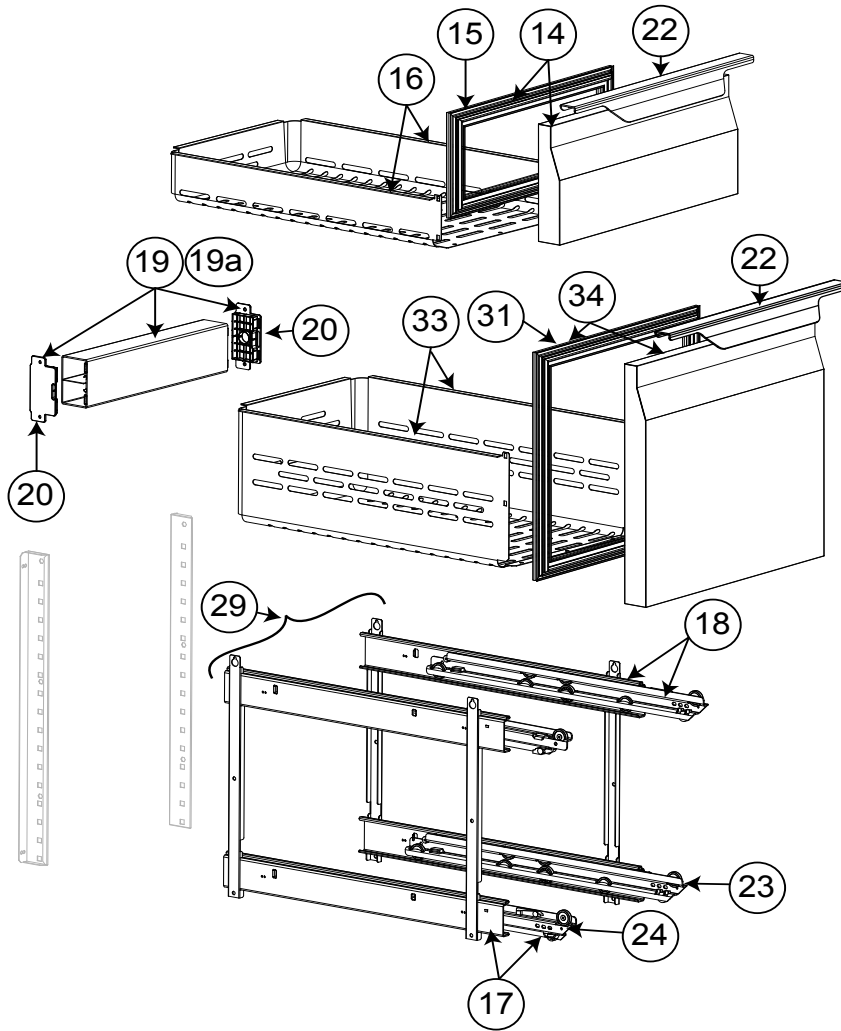

881R70800

APX/ZAN H700
BOTTLE DRAW.

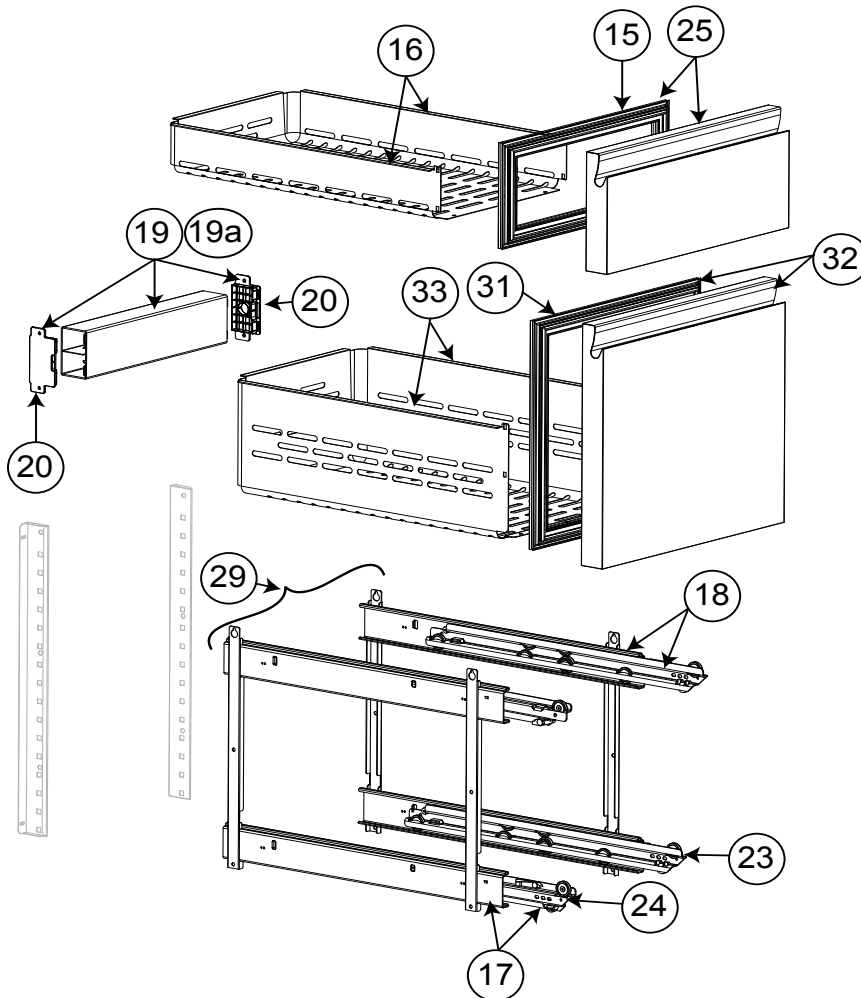

881R70700

Pos	Code	Factory code	Description	Descrizione	Ref/notes
reference pag. 5-6-7					
Doors and Drawers			Porta e Cassetti		
1	095802	835R52104	FOAMED D. ASSEMBLY H700 apx/zan	PORTA SCHIU. CON GUARNI.APX_ZAN	brand Apx_Zan
2	095238	548R11101	A886 MAGNETIC GASKET H700	GUARNIZIONE PORTA	
3	095227	503R09702	FRONT SUPPORT GRIDS H700	FRONTALE SUPPORTO GUIDE	
4	095228	502R84601	LEFT GUIDE FOR SHELF	GUIDA A "C" SX TAV NGC H700/H650	
5	095229	502R84701	RIGHT GUIDE FOR SHELF	GUIDA A "C" DX TAV NGC H700/H650	
6	095231	514R23500	SHELF	GRIGLIA RILSAN TAVOLO H650/H700	
7	095326	505R23702	LOWER HINGE H650/H700	CERNIERA INFERIORE	
8	095327	505R23803	UPPER HINGE H650/H700	CERNIERA SUPERIORE	
9	087667	514746701	PIN FOR DOOR	PERNO PER CERNIERA INFERIORE	
10	089146	800735200	DOOR OPENING END COURSE	PIASTRINA FERMO BATTUTA PORTA	
11	081807	549700000	DOOR BUSH	BOCCOLA X CERNIERA	
12	095511	835R51907	FOAMED DOOR ASSEMBLY H700 elux	PORTA CON GUARNIZIONE ELECTR.	brand: Elux
13	095328	503R01004	DOOR HANDLE ELECTROLUX H 700	MANIGLIA PORTA ELECTROLUX	brand: Elux
14	095512	835R53506	FOAMED DRAWERS 1/3 ELUX	ASS.CASS.1/3 SCHIUM. TAVOLO ELEC	brand: Elux (+GASKET)
15	095240	548R11801	GASKET DRAWER 1/3	GUARNIZ.CASS.1/3 TAV NGC H700	
16	095551	833R36003	1/3 DRAW+GUIDES (WITHOUT FRONTAL)	ASS.INVOLUCRO CASSETTO+GUIDE	
17	095266	832R23200	LEFT SUPPORT DRAWERS 1/3	CARRELLO SX PER MOD.CASSETTI	
18	095267	832R23300	RIGHT SUPPORT DRAWERS 1/3	CARRELLO DX PER MOD.CASSETTI	
19	095365	875R33501	CROSSBEAM ASSEMBLY - DRAWERS	TRAVERSA CASSETTO 1/ E 1/2 TN	only refrigerated Up to 2019/13
19	096130	835R70800	CROSSBEAM ASSEMBLY - DRAWERS	TRAVERSA CASSETTO TN	only refrigerated From 2019/14
19a	095366	835R53801	FOAM PILLAR ASS. - DRAWERS	TRAVERSA CASSETTO 1/ E 1/2 BT	only freezer
20	095552	543R18901	PLASTIC PILLAR PLUG RIGHT/LEFT	TAPPO TRAVERSA DX E SX	only refrigerated
21	095553	833R37202	1/3 SUPPORT +GUIDE ASSEMBLY	SUPPORTO TELAIO DX E SX CASS.1/3	
22	095348	503R08703	HANDLE DRAWERS ELUX	MANIGLIA CASS. ELECTROLUX NGC	brand: Elux
23	095267	832R23300	RIGHT SLIDING GUIDE	GUIDA SCORREVOLE DX	
24	095266	832R23200	LEFT SLIDING GUIDE	GUIDA SCORREVOLE SX	
25	095554	835R54205	FOAMED FRONT DRAW. 1/3 APX/ZAN	ASS.CASS.1/3 SCHIUMATO	brand Apx_Zan (+GASKET)
26	095822	835R54106	FOAMED FRONT DRAW. 1/2 ELUX	ASS.CASS.1/2 SCHIUMATO ELEC	brand: Elux (+GASKET)
27	095239	548R11701	GASKET DRAWER 1/2	GUARNIZ.CASS.1/2 TAV NGC H700	
28	095814	833R35904	1/2 DRAW+GUIDES (WITHOUT FRONTAL)	INVOLUCRO CON GUIDE	
29	095555	833R37302	1/2-2/3 SUPPORT +GUIDE ASSEMBLY	SUPP. TELAIO DX E SX CASS.1/2-2/3	
30	095556	835R54305	FOAMED FRONT DRAW. 1/2 APX_ZAN	ASS.CASS.1/2 SCHIUM. ZAN_APX	brand Apx_Zan (+GASKET)
31	095249	548R12500	GASKET DRAWER 2/3	GUARNIZ.CASS.2/3 TAV NGC H700	
32	095557	835R57704	2/3 FOAM. FRONT DRAW. ASS. ALPEN	ASS.CASS.2/3 SCHIUM. ZAN_APX	brand Apx_Zan (+GASKET)
33	095558	833R38500	2/3 DRAW+GUIDES (WITHOUT FRONTAL)	ASS. INVOLUCRO CASS.+GUIDE 2/3	
34	095559	835R57505	2/3 FOAM.FRONT DRAW. ASS. ELUX	ASS.CASS.2/3 SCHIUM. TAVOLO ELUX	brand: Elux (+GASKET)
*	095300		INCLUDE N°23 AND N°24 (1RIGHT +1 LEFT)	INCLUDE N°23 E 24,(1+1 GUIDA DX-SX)	
36					

* = On demand

MODEL=H7NTN4BHC

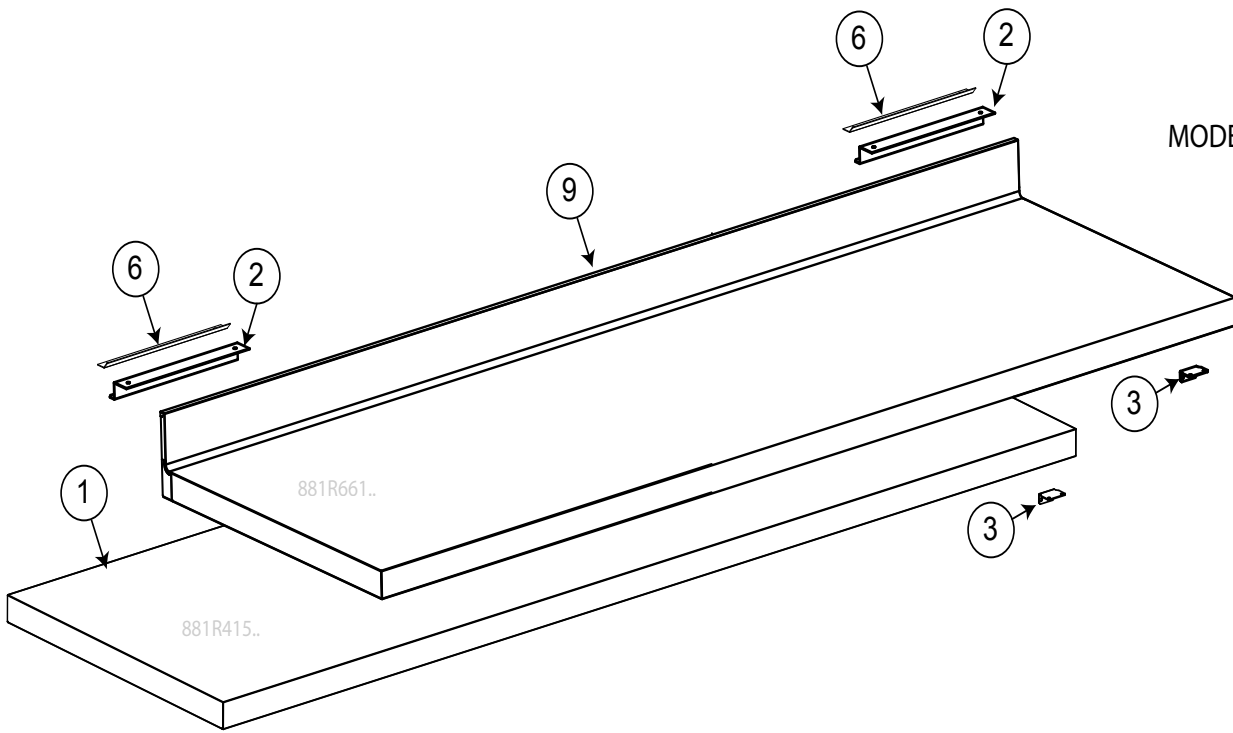

MODEL= H7NTN3BHC
H7NBT3BHC
H7NBT3B

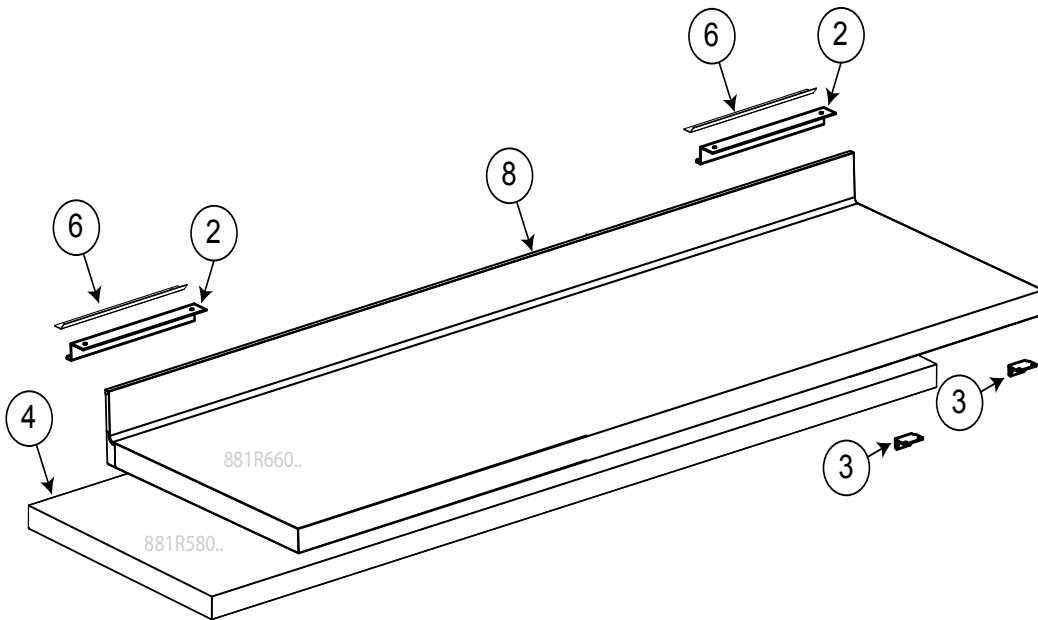

MODEL=H7NTN2BHC
H7NBT2BHC
H7NBT3B

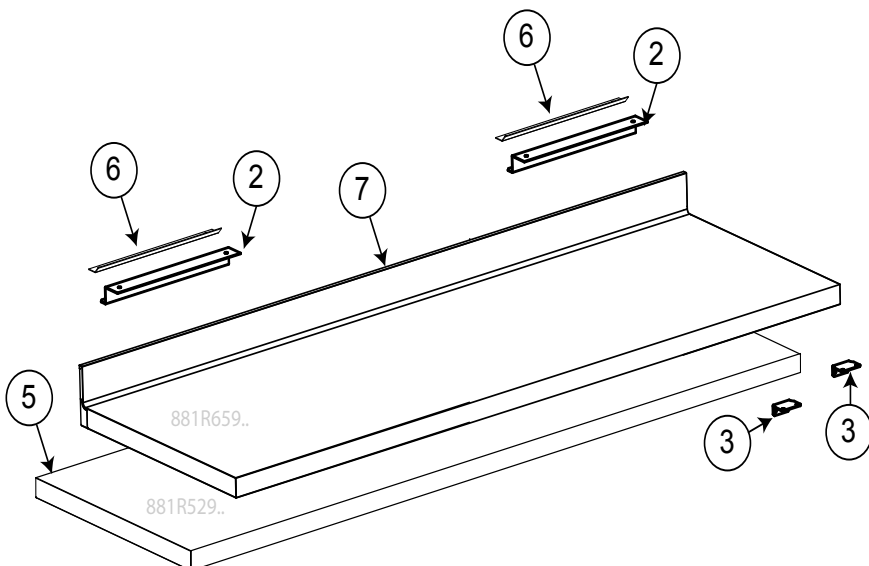

Pos	Code	Factory code	Description	Descrizione	Ref/notes
reference pag.9					
Worktop			Top		
1		881R41504	WORKTOP MODULE 4C H50 "R-L"	TOP 4 VANI H 50 DX-SX	c (without S.back)
2		501775700	HOOK FOR TOP	GANCIO PER RIPIANO	
3	095330	505R25301	BRACKET SHELF	STAFFA PER RIPIANO	
4	095562	881R58003	WORKTOP MODULE 3C H50 "R-L"	TOP 3 VANI H 50 DX-SX	b,e (without S.back)
5	095564	881R52904	WORKTOP MODULE 2C H50 "R-L"	TOP 2 VANI H 50 DX-SX	a,d (without S.back)
6	093186	505751500	HOOK FOR TOP ON THE COUNTER	FISSAGGIO RIPIANO AL TAVOLO	
7	095367	835R57201	WORKTOP ASS. WITH S.BACK 2C "R-L"	TOP CON ALZATINA 2 VANI DX-SX	a,d (whit S.back)
8	095368	835R57301	WORKTOP ASSEMBLY 3C S/BACK "R-L"	TOP CON ALZATINA 3 VANI DX-SX	b,e (whit S.back)
9	095369	835R57401	WORKTOP ASS. WITH S.BACK 4C "R-L"	TOP CON ALZATINA 4 VANI DX-SX	c (whit S.back)
10					
11					
12					
13					
14					
15					
16					
17					
18					
19					
20					
21					
22					
23					
24					

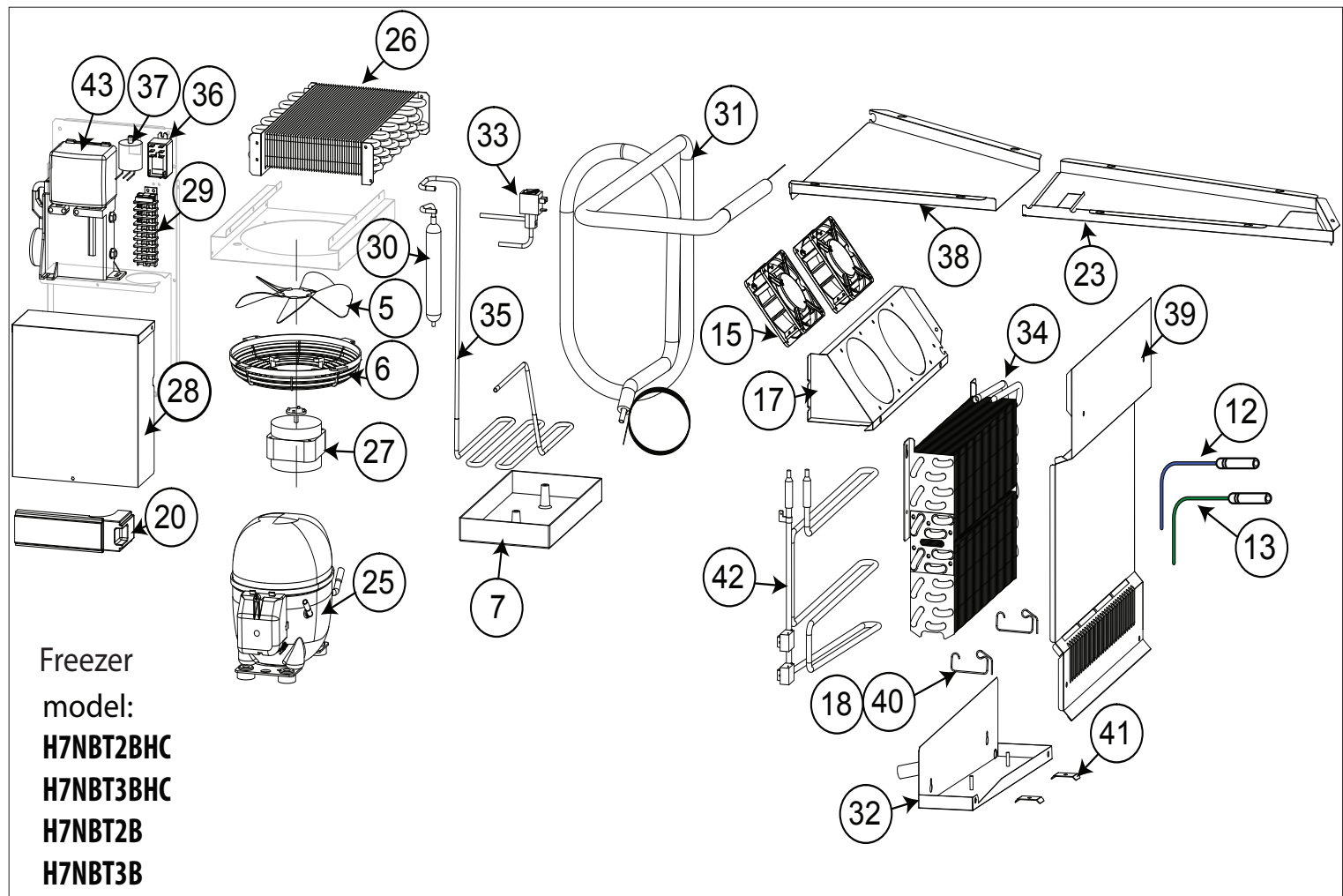
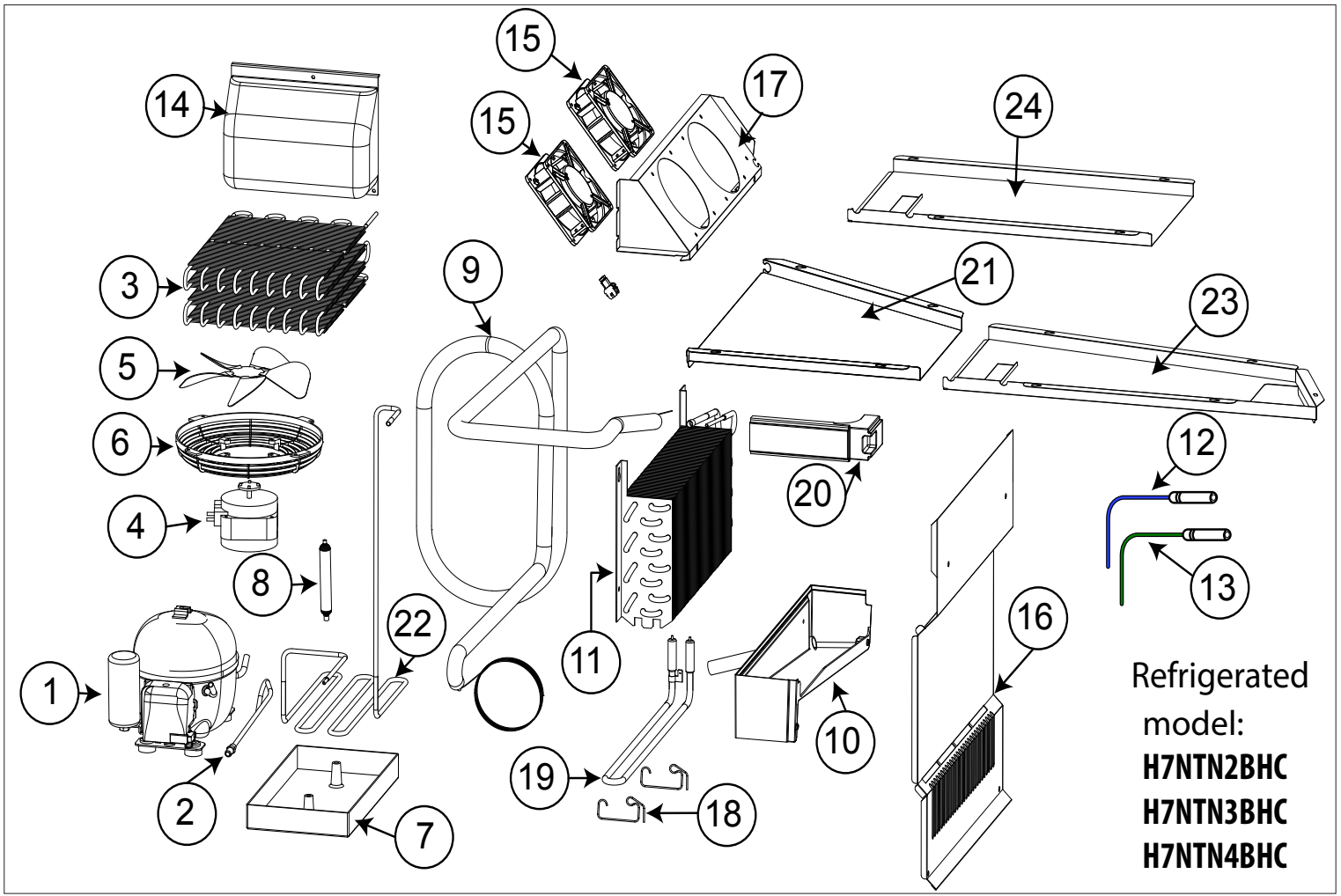

Pos	Code	Factory code	Description	Descrizione	Ref/notes
Pag. 11					
Cooling unit 2-3-4 comp. R290 refrigerated /freezer			Gruppo 2-3-4 vani R290 refrigerato e freezer		
1	093425	684R05700	COMPRESS. EMT6144U 220-50 R290	COMPRESS. EMT6144U 220-50 R290	a,b,c
2	093223	515R14600	PIPE WHIT CHARGE VALVE	TUBO VALV. DI CARICA	a,b,c
3	095271	830R11103	WIRING CONDENSER	CONDENSATORE FILI	a,b,c
4	094184	682R07700	CONDENSER FAN MOTOR	VENTILATORE 10 220-240V 50/60HZ	a,b,c
5	082874	511701900	FAN CONDENSER	VENTOLA ASP.A200-34 4012201	
6	089770	546709600	PROTECTION FAN CONDENSER	GRIGLIA SUPP.MOTOVENT.DIAM.200	
7	084585	549727300	CONDENSER WATER BASIN	BACINELLA RACC.CONDENSEA	
8	099949	858R00100	DEHYDRATOR FILTER	FILTRO GR.15 2 VIE FORI DIAM.2,5-5,0	a,b,c
9	095287	858R15301	HEAT EXCHANGER	ASS. SCAMBIATORE PIEGATO 290 TN	a,b,c
10	095288	546R39801	WATER COLLECTOR BASIN	BACINELLA EVAPORATORE	a,b,c
11	095290	830R12301	EVAPORATOR	EVAPORATORE 8RH 3RD 25X22	a,b,c
12	092175	0646R06900	BLUE PROBE CELL	SONDA 6X20 BLU 'CELL' L=3000	
13	096125	0646R07701	GREEN PROBE EVAP.	SONDA 6X40 VERDE 'DEF' L=3000	
14	095275	546R36901	PLASTIC ELECTRIC BOX	COPERTURA BOX ELETTRICO	a,b,c
15	095315	682R10700	EVAP FAN 120X120X38 MM IP55	VENTILATORE EVAPORATORE	
16	095294	503R01302	EVAPORATOR COVER	COPERTURA EVAPORATORE TAV. TN	a,b,c
17	095359	503R01203	FANS SUPPORT EVAPORATOR	SUPPORTO VENTILATORI CELLA	
18	095279	514R24201	SPRING RETAINING HEATER	MOLLA FIX. RESISTENZA TAV NGC TN	a,b,c
19	095316	617R17500	HEATER EVAPORATOR	RESISTENZA DI SBRINAMENTO	a,b,c
20	095225	569R09502	EPS INSULATING BLOCK	ISOLAMENTO PER SCAMBIATORE	
21	095295	503R23900	COMMON PART AIR CONVEYOR TN	CONVOGLIATORE ARIA PORTE	a,b,c
22	095274	515R32201	SERPENTINE PIPE	TUBO DA COND A COMPR TAV TN	a,b,c
23	095296	503R24100	END PART AIR CONVEYOR TN/BT HP	CONVOGLIATORE FINALE	b,c,e,g (with drawer)
24	095297	503R24000	MID PART AIR CONVEYOR HP A304 "L"	CONVOGLIATORE CENTRALE	c (with drawer)
25	094840	684R11900	COMPRESSOR NEU2168U R290	COMPRESSORE NEU2168U R290	d,e
25	095613	684R12900	COMPRESSOR NEU2178U R404a	COMPRESSORE NEU2178U R404a	f,g 50Hz
25	095645	684R13600	COMPRESSOR NEU2155GK 60HZ	COMPRESSORE NEU2155GK 60HZ	f,g 60Hz
26	095352	830R12601	CONDENSER FREEZER	CONDENSATORE BT NGC	d,e,f,g
27	094487	0682R08700	MOTOR FAN CONDENSER	VENTILATORE EBM -1800 RPM -	d,e
27	095612	0682R10800	MOTOR FAN CONDENSER	VENTILATORE EBM -1800 RPM -	f,g
28	095354	503R29102	ELECTRIC BOX COVER	PROTEZIONE IMPIANTO ELETTRICO	d,e d,e,f,g
29	095666	639R16600	MAIN TERMINAL BLOCK	MORSETTIERA	d,e,f,g
30	084078	805729802	DEHYDRATOR FILTER	FILTRO GR.40 D.24	d,e,f,g
31	095298	858R15600	HEAT EXCHANGER	ASS. SCAMBIATORE PIEGATO 290 BT	d,e,f,g
32	095362	502R93301	WATER COLLECTOR BASIN COUNTER	BACINELLA RACCOLTA CONDENSEA	d,e,f,g
33	094435	646R10502	SOLENOID VALVE EVR	ELETTROVALVOLA PARKER WB4,5 6W	d,e,f,g
34	095363	830R12801	FINNED COIL EVAPORATOR 12RH 3RD	EVAPORATORE FREEZER	d,e,f,g
35	095357	515R33701	PIPE FROM COMP. TO CONDENS.	TUBO DA COND A COMPR TAV TN	d,e,f,g
36	095281	648R08400	RELAY FINDER 66.82.8.230.0003	RELÈ' FINDER 66.82.8.230.0003	d,e,f,g up to 2019/38
36	093848	648R06300	RELAY FINDER 66.82.8.230.0001	RELÈ' FINDER 66.82.8.230.0001	d,e,f,g from 2019/39
37	092257	0694R00501	EMC FILTER	FILTRO ANTIDIST. 411.13.2010 3	d,e,f,g
38	095299	503R24200	AIR CONVEYOR BT HP "L" A304	CONVOGLIATORE ARIA FREEZER	d,e,f,g
39	093518	503R28501	EVAPORATOR COVER FREEZER	COPERTURA EVAPORATORE FREEZ.	d,e,f,g
40	095283	503R29400	ALUMINIUM TIE	FASCETTA IN ALLUMINIO	d,e,f,g
41	095282	503R29200	ARMOURED HEATER FIXING BRACK.	STAFFE DI FISSAGGIO RESISTENZA	d,e,f,g
42	095364	617R16801	ARMOURED HEATER FREEZER "L"	RESISTENZA BI-POTENZIALE BT	d,e,f,g
43	*	*	ELECTRICAL BOX COMPRESSOR	SCATOLA BOX COMPRESSORE	d,e,f,g
*	0A8171	A02021800	SCHRADEN RECHARGEABLE VALVE	VALVOLA DI RICARICA	d,e,f,g

HP range

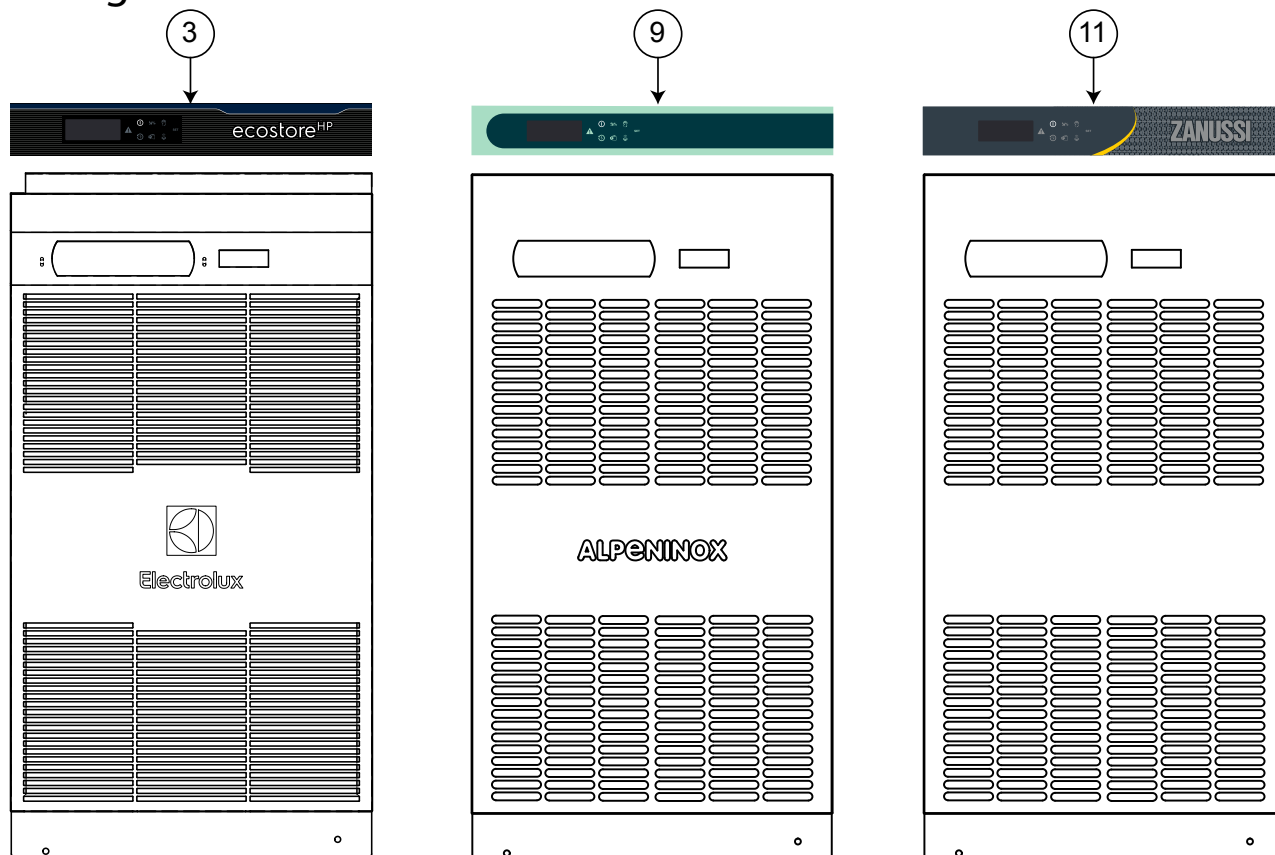

2

8

10

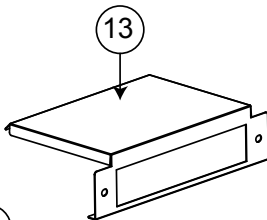
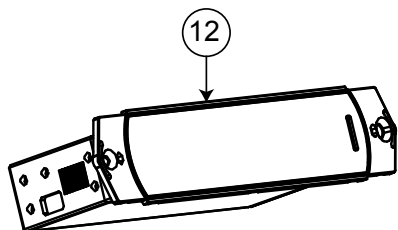

1

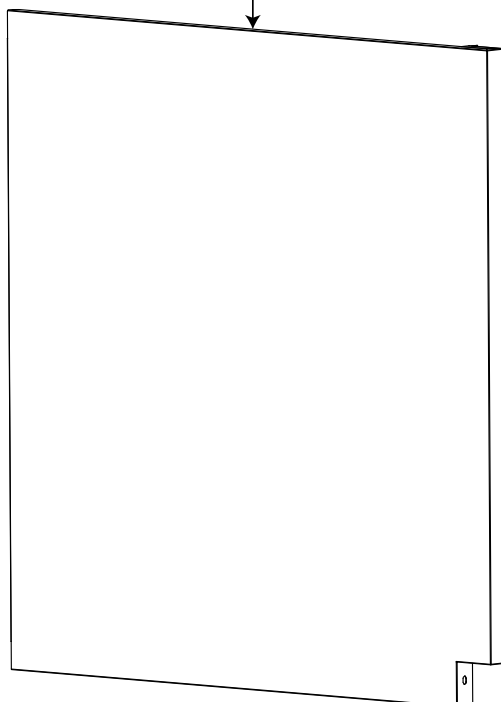

4

5

6

7



MODEL=H7NTN2BHC
 H7NTN3BHC
 H7NTN4BHC
 H7NBT2BHC
 H7NBT3BHC

Concept line range

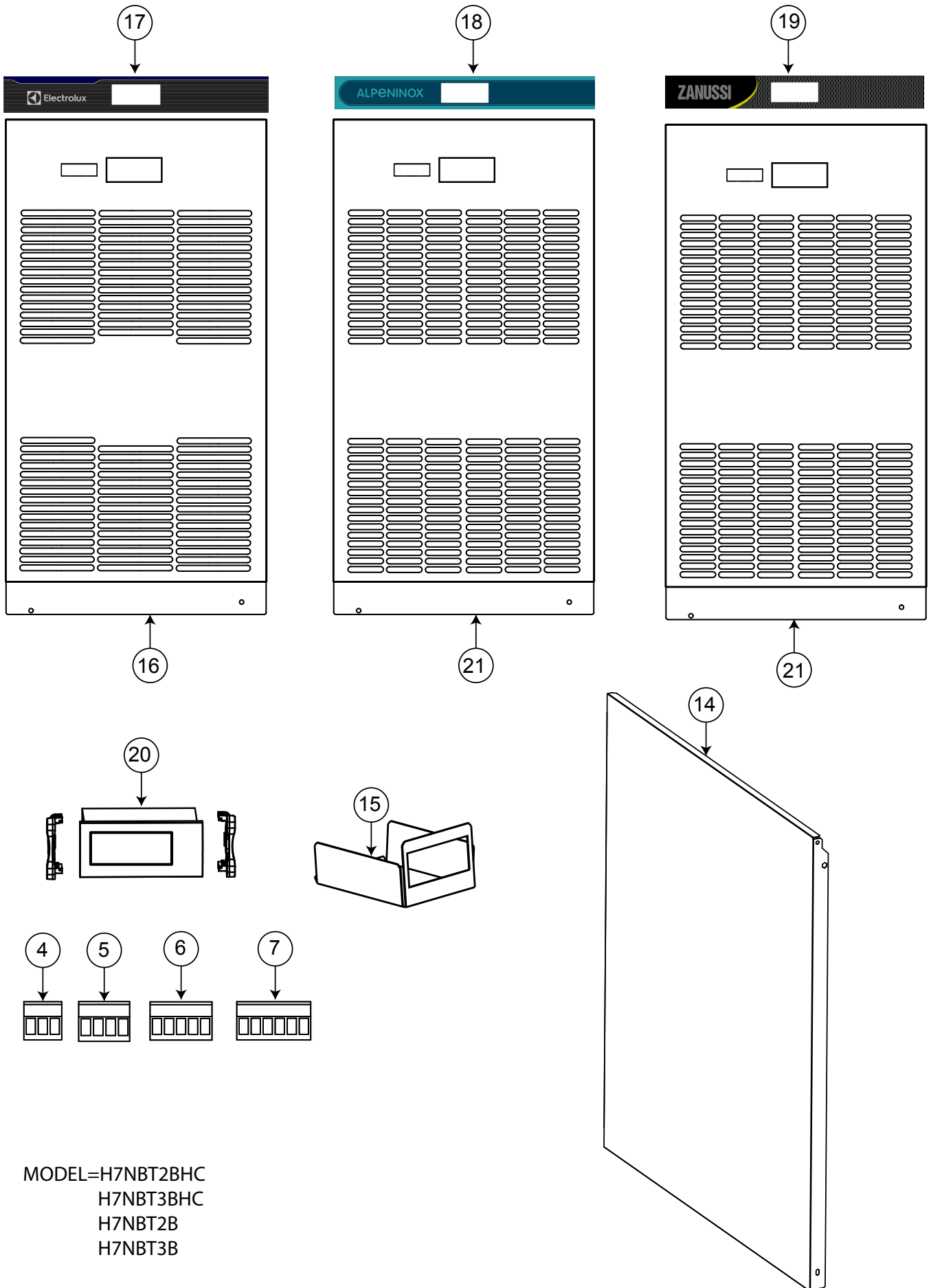

MODEL=H7NBT2BHC
 H7NBT3BHC
 H7NBT2B
 H7NBT3B

Pos	Code	Factory code	Description	Descrizione	Ref/notes
reference pag.11					
Control panel			Pannello di controllo		
1	095247	502R85102	EXTERNAL SIDE PANEL H700 HP	PANNELLO ESTERNO HP	a,b,c,d,e
1	095631	0503R62601	EXTERNAL SIDE PANEL H700 HP	PANNELLO ESTERNO HP	d (R290),e (R290),f,g
2	095686	833R37403	SCREEN PRINTED ASSEMBLY ELEC.	PANNELLO ELECTROLUX ASSEMB.	(ELECTROLUX) HP
3	095248	755R09502	STICKER CONTROL ELUX REFRIGER.	MEMBRANA CON TASTI ELUX TN	a,b,c (ELECTROLUX) HP
3	095284	755R10800	STICKER CONTROL ELUX FREEZER	MEMBRANA CON TASTI ELUX BT	d,e (ELECTROLUX) HP
4	088998	639722900	CONNECTOR MSTB 2.5/3 ST PASSO 5	CONETTORE PASS.5 MSTB 2.5/3 ST	
5	091682	0639R04400	CONNECTOR MSTB 2.5/4 ST PASSO 5	CONETTORE PASS.5 MSTB 2.5/4 ST	
6	*	639725900	CONNECTOR MSTB 2.5/5 ST PASSO 5	CONETTORE PASS.5 MSTB 2.5/5 ST	
7	095244	0639723400	CONNECTOR MSTB 2.5/6 ST PASSO 5	CONETTORE PASS.5 MSTB 2.5/6 ST	
8		509R20900	CTRL PANEL COUNTER HP PREM	PANNELLO CONTROLLO APX	a,b,c (ALPENINOX) HP
9	095250	755R10000	STICKER CONTROL APX REFRIGER.	MEMBRANA CON TASTI APX TN	a,b,c (ALPENINOX) HP
9	095285	755R10900	STICKER CONTROL APX FREEZER	MEMBRANA CON TASTI APX BT	d,e(ALPENINOX) HP
10	095342	509R21002	CTRL PANEL COUNTER HP PREM	PANNELLO CONTROLLO ZANUSSI	a,b,c (ZANUSSI) HP
11	095251	755R10300	STICKER CONTROL ZANUSSI REFRIG.	MEMBRANA CON TASTI ZANUSSI TN	a,b,c (ZANUSSI) HP
11	095286	755R11000	STICKER CONTROL ZANUSSI FREEZ.	MEMBRANA CON TASTI ZANUSSI BT	d,e (ZANUSSI) HP
12	095252	646R13500	THERM.REG.EASYWIDE 115/230VAC	TERMOREG.EASYWIDE 115/230VAC	a,b,c,d,e HP
13	095343	503R45400	EASY WIDE COVER	PROTEZIONE TERMOREGOLATORE	a,b,c,d,e HP
14	095247	502R85102	EXTERNAL SIDE PANEL H700 HP	PANNELLO ESTERNO HP	a,b,c,d,e
14	095631	0503R62601	EXTERNAL SIDE PANEL H700 HP	PANNELLO ESTERNO HP	d (R290),e (R290),f,g
15	095565	503R68400	IR33 COVER COUNTERS C.L.	PROTEZIONE TERMOREGOLATORE	d,e,f,g CL
16		509R24000	CTRL PANEL CL H700 ELX "L" FZ	PANNELLO CONTROLLO CL FREEZER	d,e,f,g CL (ELUX)
17	095668	755R14601	STICKER CONT. CL FR IR33 ELX L-R	MEMBRANA ELX BT IR33 CL	d,e,f,g CL (ELUX)
*	092134	147017028	NEOPRENE	NEOPRENE ESP.CELL.CHIUSE 8X10	
18	095667	755R14500	STICKER CONT. CL FR IR33 APX L-R	MEMBRANA APX BT IR33 CL	d,e,f,g CL (APX)
19	095615	755R14700	STICKER CONT. CL FR IR33 ZAN L-R	MEMBRANA ZAN BT IR33 CL	d,e,f,g CL (ZAN)
20	093434	646R11101	TERMOREGOLAT. CAREL IR33	TERMOREGOLAT. CAREL IR33	d,e,f,g CL
21		509R22601	CTRL PANEL CL H700 "R" FZ	PANNELLO CONTROLLO CL FREEZER	d,e,f,g CL
22					
23					



NordCap GmbH & Co. KG
Thalendorststraße 15
28307 Bremen
Hauptsitz (Service, Finanzen & Personal, Lager, IT, Marketing)

Telefon: +49 421 48557-0
Telefax: +49 421 488650
E-Mail: bremen@nordcap.de

Die NordCap Verkaufsniederlassungen in Deutschland:

Nord: Hamburg • Ost: Berlin • Süd: Ingelheim • West: Erkrath



ALPENINOX