

01	AGGIORNAMENTO NUMER. MORSETT. SONDE	14.09.2023	DT
REV.	MODIFICATION	DATE	SIGNATURE

li GROUP

DATE: 11.01.2023
 DRAWN BY: David T.
 CHECKED: D. T.
 APPROVED: D. T.

F.R.C.
 Via Cav. di Vitt. Veneto 25
 32036 - Sedico (BL)
 FILE :

STANDARD UNITS

RATED VOLTAGE:
220-240V ~ 50/60Hz

WIRING DIAGRAM CODE:
BN6SCRO231BD01

REV: **01** SHEET: **2**
 TOT. SH.: **6**

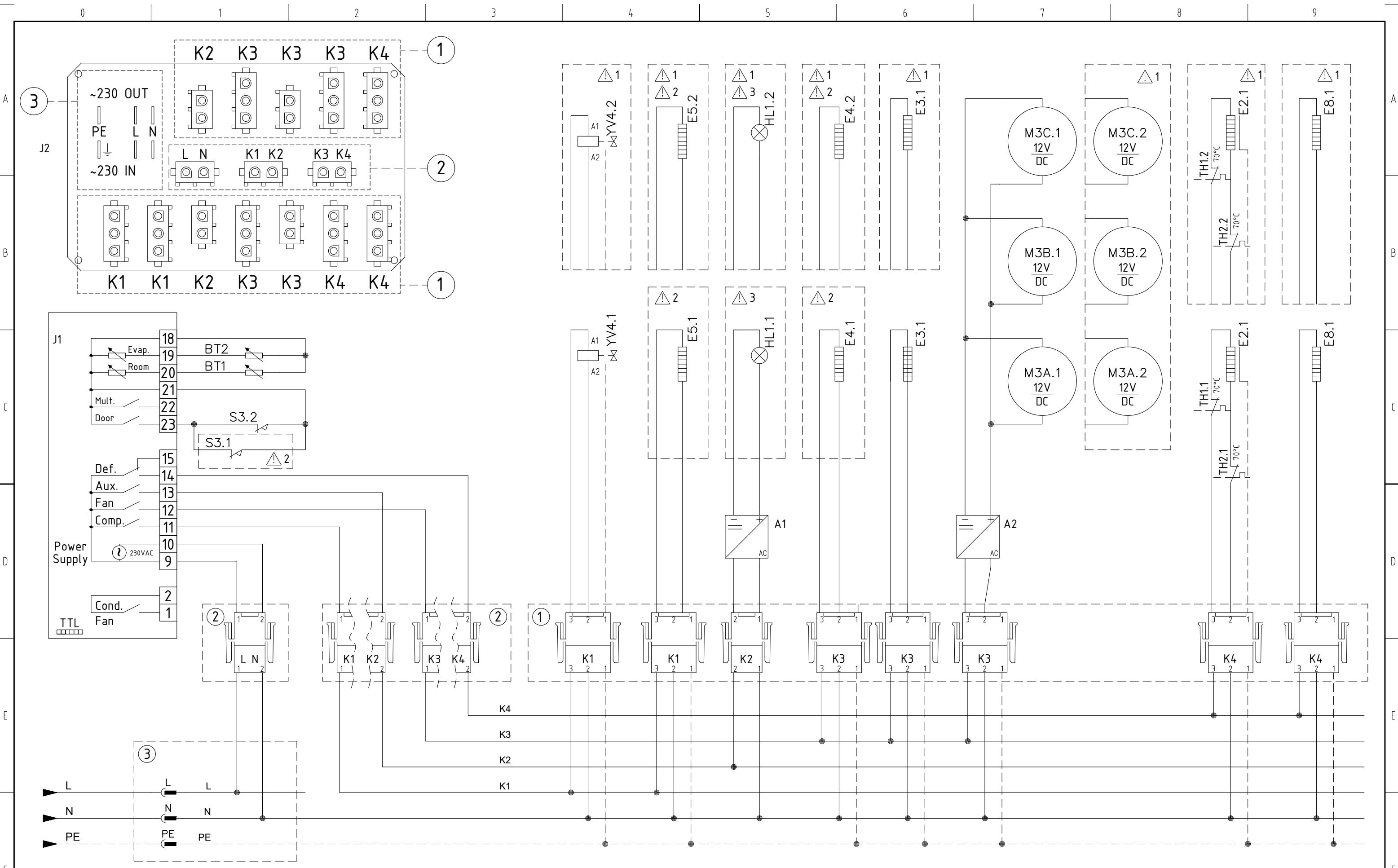

01	AGGIORNAMENTO NUMER. MORSETT. SONDE	14.09.2023	DT
REV.	MODIFICATION	DATE	SIGNATURE













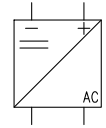

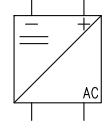

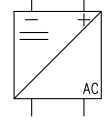

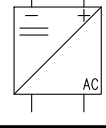
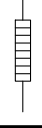





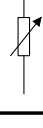

DATE	11.01.2023
DRAWN BY	David T.
CHECKED	D. T.
APPROVED	D. T.

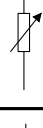
F.R.C.
Via Cav. di Vitt. Veneto 25
32036 - Sedico (BL)
FILE :

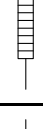
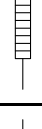
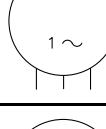
ONLY FOR REMOTE UNITS

RATED VOLTAGE:	
220-240V ~ 50/60Hz	
WIRING DIAGRAM CODE:	
BN6SCRO231BD01	
REV:	SHEET: 3
01	TOT. SH.: 6

LISTA FUNZIONI \ FUNCTIONS LIST

Componente	Ref.	Funzione Function	Componente	Ref.	Funzione Function	Componente	Ref.	Funzione Function
	A1 +BM 2	Alimentatore Power supply unit Alimentateur Stromversorgung Alimentador		E3.1 +BM 3	Resistenza bacinella autoevaporante Resistance of self-evaporating tray Résistance cuve autoévaporante Widerstand selbstverdampfende Wanne Resistencia cubeta autoevaporante		E8.1 +BM 3	Resistenza gocciolatoio Drip tray resistance Résistance égouttoir Widerstand Tropfwanne Resistencia escurridor
	A1 +BM 3	Alimentatore Power supply unit Alimentateur Stromversorgung Alimentador		E4.1 +BM 2	Resistenza cornice Door frame heating element Résistance cadre Rahmen-Heizelement Resistencia marco		E8.1 +BM 3	Resistenza gocciolatoio Drip tray resistance Résistance égouttoir Widerstand Tropfwanne Resistencia escurridor
	A2 +BM 3	Alimentatore Power supply unit Alimentateur Stromversorgung Alimentador		E4.1 +BM 3	Resistenza cornice Door frame heating element Résistance cadre Rahmen-Heizelement Resistencia marco		HL1.1 +BM 3	Lampada illuminazione Illumination light Lampe éclairage Beleuchtung Lámpara iluminación
	A2 +BM 2	Alimentatore Power supply unit Alimentateur Stromversorgung Alimentador		E4.2 +BM 2	Resistenza cornice Door frame heating element Résistance cadre Rahmen-Heizelement Resistencia marco		HL1.1 +BM 2	Lampada illuminazione Illumination light Lampe éclairage Beleuchtung Lámpara iluminación
	BT1 +BM 2	Sonda cella Cell probe Sonde cellule Zellsonde Sonda celda		E4.2 +BM 3	Resistenza cornice Door frame heating element Résistance cadre Rahmen-Heizelement Resistencia marco		HL1.2 +BM 3	Lampada illuminazione Illumination light Lampe éclairage Beleuchtung Lámpara iluminación
	BT1 +BM 3	Sonda cella Cell probe Sonde cellule Zellsonde Sonda celda		E5.1 +BM 3	Resistenza scarico Discharge heating element Résistance déchargement Auspuff-Widerstand Resistencia descarga		HL1.2 +BM 2	Lampada illuminazione Illumination light Lampe éclairage Beleuchtung Lámpara iluminación
	BT2 +BM 2	Sonda evaporatore Evaporator probe Sonde évaporateur Verdampfer-sonde Sonda evaporador		E5.1 +BM 2	Resistenza scarico Discharge heating element Résistance déchargement Auspuff-Widerstand Resistencia descarga		J1 +QG 3	Scheda di controllo principale e HMI Main control board and HMI Carte de contrôle principal et HMI Hauptsteuerkarte und HMI Tarjeta de control principal y HMI
	BT2 +BM 3	Sonda evaporatore Evaporator probe Sonde évaporateur Verdampfer-sonde Sonda evaporador		E5.2 +BM 2	Resistenza scarico Discharge heating element Résistance déchargement Auspuff-Widerstand Resistencia descarga		J1 +QG 2	Scheda di controllo principale e HMI Main control board and HMI Carte de contrôle principal et HMI Hauptsteuerkarte und HMI Tarjeta de control principal y HMI
	E2.1 +BM 3	Resistenza sbrinamento Defrosting resistance Résistance dégivrage Abtauwiderstand Resistencia descongelación		E5.2 +BM 3	Resistenza scarico Discharge heating element Résistance déchargement Auspuff-Widerstand Resistencia descarga		M1.1 +BM 2	Compressore Compressor Compresseur Verdichter Compresor
	E2.1 +BM 3	Resistenza sbrinamento Defrosting resistance Résistance dégivrage Abtauwiderstand Resistencia descongelación		E8.1 +BM 2	Resistenza gocciolatoio Drip tray resistance Résistance égouttoir Widerstand Tropfwanne Resistencia escurridor		M1.1 +BM 2	Compressore Compressor Compresseur Verdichter Compresor
	E3.1 +BM 3	Resistenza bacinella autoevaporante Resistance of self-evaporating tray Résistance cuve autoévaporante Widerstand selbstverdampfende Wanne Resistencia cubeta autoevaporante		E8.1 +BM 2	Resistenza gocciolatoio Drip tray resistance Résistance égouttoir Widerstand Tropfwanne Resistencia escurridor		M2.1 +BM 2	Ventilatore condensatore Condenser fan Ventilateur condensateur Ventilator Verflüssiger Ventilador condensador

01	AGGIORNAMENTO NUMER. MORSETT. SONDE	14.09.2023	DT		DATE	11.01.2023	F.R.C. Via Cav. di Vitt. Veneto 25 32036 - Sedico (BL)	RATED VOLTAGE: 220-240V ~ 50/60Hz			
REV.	MODIFICATION	DATE	SIGNATURE		DRAWN BY	David T.		FILE :	Legenda Funzioni	WIRING DIAGRAM CODE: BN6SCRO231BD01	REV: 01
					CHECKED	D. T.				TOT. SH: 6	SHEET: 4

