

# Ersatzteilliste-Explosionszeichnung

## Induktionsherd IH7 / 4ZT

[Art. 406372021]



## INDUZIONE TOP E700XP INDUCTION COOKING TOP E700XP

PNC	Model	Ref	Brand	Notes
371020	E7INED2000	A	ELX	400 MM
371021	E7INEH4000	B	ELX	800 MM
371131	E7INED200N	C	ELX	400 MM-230V
371132	E7INEH400N	D	ELX	800 MM-230V
371175	E7INED200P	E	ELX	HP 400 MM
371176	E7INEH400P	F	ELX	HP 800 MM
372020	Z7INED2000	G	ZAN	400 MM
372021	Z7INEH4000	H	ZAN	800 MM
372131	Z7INED200N	I	ZAN	400 MM-230V
372132	Z7INEH400N	J	ZAN	800 MM-230V
372175	Z7INED200P	K	ZAN	HP 400 MM
372176	Z7INEH400P	L	ZAN	HP 800 MM
373020	A7INED2000	M	OEM	400 MM
373021	A7INEH4000	N	OEM	800 MM
373131	A7INED200N	O	OEM	400 MM-230V
373132	A7INEH400N	P	OEM	800 MM-230V

**Index**

General components / Componenti struttra  
Spare parts list / Lista ricambi

**Page**

2  
3,4

**Notes**

For Art.17,22,23 please refer to Tech.Bulletin PDX2017-01 - PDX2019-01.

For appliances manufactured before Ser.4341 refer to spc 59785DQ00.

This spc is related to appliances manufactured From Ser. Nr/ Da Ser. Nr.: 4341

**Bold=last change / Grassetto =ultima modifica**

Rev. 4

From Ser. Nr. 4341 Up to Ser. Nr.	Ed. 2018-01 Updated 2020-07	Page: 1	<b>Doc No:59785TD00</b>
--------------------------------------	--------------------------------	---------	-------------------------

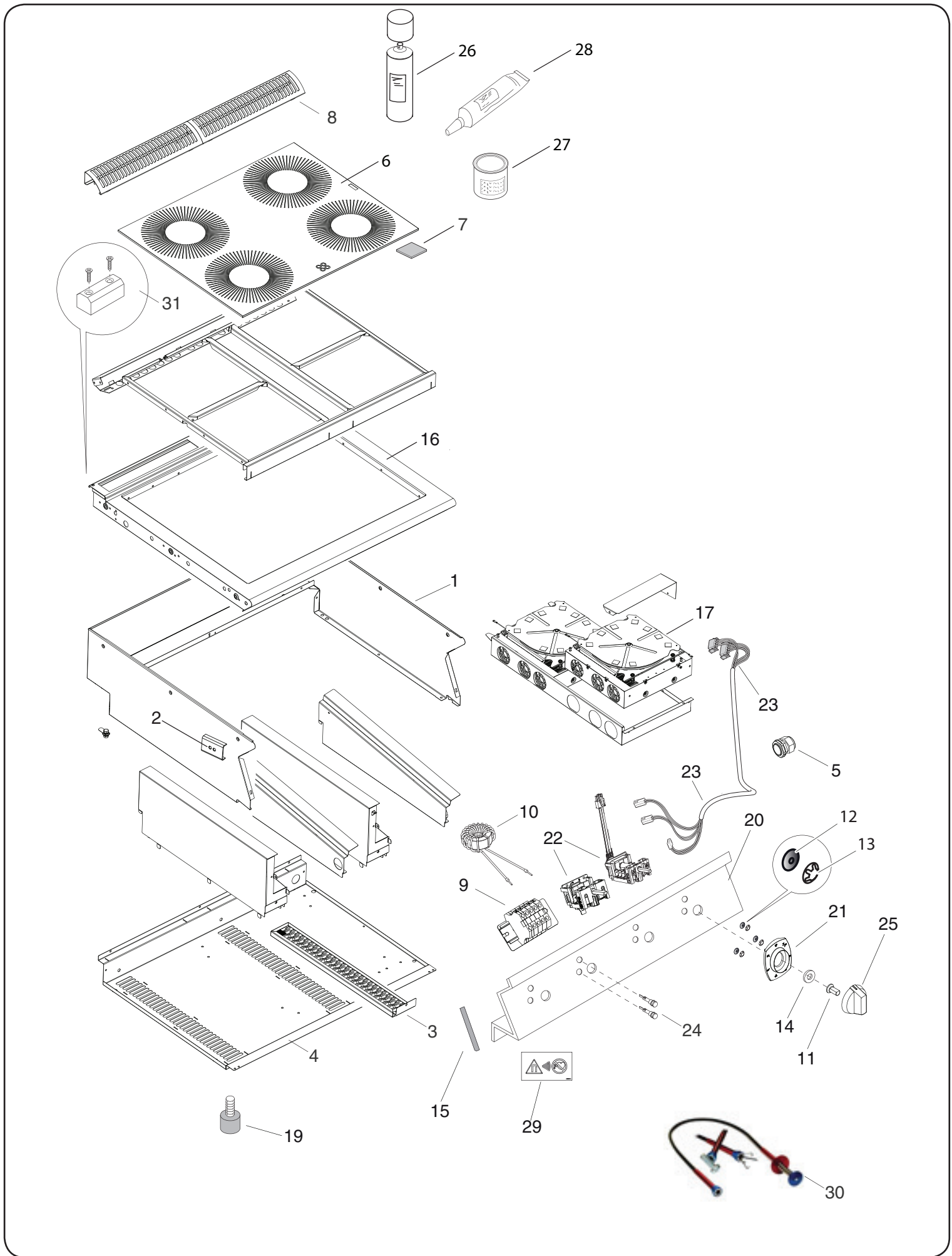

INDUZIONE TOP E700XP  
INDUCTION COOKING TOP E700XP

Pos	Factory Code	Spare Code	Descrizione	Description	Ref./Notes
1	085089F701	0C8544	FASCIA	PANEL	ELX 400
1	085089F801	0C7536	FASCIA	PANEL	ELX 800
1	085089FA01	0C7268	FASCIA	PANEL	ZAN, OEM 400
1	085089FB01	0C8464	FASCIA	PANEL	ZAN, OEM 800
2	0527850500	0C0156	STAFFA INTERNA UNIONE	INNER JUNCTION BRACKET	
3	085589AR00	0C7191	AIR FILTRO	AIR FILTER	
4	050389Q301	*	FONDO INDUZIONE 400mm	BOTTOM PANEL 400mm	400
4	050389Q403	0CB302	FONDO INDUZIONE 800mm	BOTTOM PANEL 800mm	800
5	0544802400	0C3528	FERMACAVO CON DADO	CABLE STOPPER WITH NUT	
6	0574820400	0C7188	VETROCERAMICA INDUZIONE	GLASS TOP	400
6	0574820300	0C7866	VETROCERAMICA INDUZIONE	GLASS TOP	800
7	0546810400	0C5419	DISTANZIATORE PER VETROCERAMICA	GLASS SPACER	
8	050389LP00	0C7333	GRIGLIA CAMINO	GRATE FOR CHIMNEY	
9	0639808700	0F0035	MORSETTIERA	MAIN TERMINAL BLOCK	C,I,O - 400-230V
9	0639806801	006238	MORSETTIERA	MAIN TERMINAL BLOCK	D,J,P; 800-230V
9	0639808700	0F0035	MORSETTIERA	MAIN TERMINAL BLOCK	A,E,G,K,M, Up to 7051
9	0639808600	0F0112	MORSETTIERA	MAIN TERMINAL BLOCK	B,F,H,L,N Up to 7051
9	0639813900	0CB058	MORSETTIERA 10MMQ	MAIN TERMINAL BLOCK 10MMQ	From 7061
10	0694806101	0CB057	FILTRO TOROIDE	TOROID FILTER	From 7061
11	0548877V00	0C7345	ADATTATORE MANOPOLA	KNOB ADAPTER	ELUX
12	0541813800	0C6171	RONDELLA SILICONE	SILICONE WASHER	
13	0218912211	069567	RONDELLA FISSAGGIO GHIERA	ORING STOPPER FOR KNOB RING	
14	0543821000	053816	GUARNIZIONE MANOPOLA	KNOB GASKET	
15	0543821900	0C2496	GUARNIZIONE PER CRUSCOTTO	GASKET, CONTROL PANEL	
16	087089B900	0C7216	RIPIANO INDUZIONE 400mm	TABLE TOP 400MM	ELX
16	087089BA00	0C7872	RIPIANO INDUZIONE 800mm	TABLE TOP 800MM	ELX
16	087089BF00	0C7654	RIPIANO INDUZIONE 400mm	TABLE TOP 400MM	ZAN, OEM
16	087089BG00	0C7655	RIPIANO INDUZIONE 800mm	TABLE TOP 800MM	ZAN, OEM
17	083089PQ00	0CB041	KIT COMPLETO RETROFIT FOUCAULT 2.1	RETROFIT KIT FOUCAULT 2.1	3,5KW 400V, A,B,G,H,M,N Up to 7051 PDX2017-01 / PDX2019-01
17	083089PN00	0CB039	GENERATORE FOUCAULT 2.1	GENERATOR FOUCAULT 2.1	3,5KW 400V, A,B,G,H,M,N From 7061 PDX2017-01 / PDX2019-01
17	83089NB01	0CB042	KIT COMPLETO RETROFIT FOUCAULT 2.1	RETROFIT KIT FOUCAULT 2.1	5KW 400V, E,F,K,L Up to 7051 PDX2017-01 / PDX2019-01
17	083089PP00	0CB665	GENERATORE FOUCAULT 2.1	GENERATOR FOUCAULT 2.1	5KW 400V, E,F,K,L From 7061 PDX2017-01 / PDX2019-01
17	083089DZ00	0C8303	KIT GENERATORE ATICS	KIT ATICS GENERATOR	3,5KW 230V, C,D,I,J,O,P
19	0315252601	026806	PIEDINO CON VITE	SCREW FOOT FOR TOP	
20	085089AZ00	0C7201	CRUSCOTTO INDUZIONE 400mm	CONTROL PANEL 400mm	ELX
20	085589A500	0C7210	CRUSCOTTO INDUZIONE 800mm	CONTROL PANEL 800mm	ELX
20	085089FU00	0C7645	CRUSCOTTO INDUZIONE 400mm	CONTROL PANEL 400mm	ZAN
20	085089FV01	0C7646	CRUSCOTTO INDUZIONE 800mm	CONTROL PANEL 800mm	ZAN
20	0800838200	*	CRUSCOTTO INDUZIONE 400mm	CONTROL PANEL 400mm	OEM
20	0800838300	*	CRUSCOTTO INDUZIONE 800mm	CONTROL PANEL 800mm	OEM
21	0548879L00	0C7640	GHIERA INDUZ POTERIORE	KNOB RING, REAR INDUCTION	ZAN, OEM
22	0641805800	0C9905	COMMUTATORE GOTTAK FOUCAULT 1	SELECTOR GOTTAK FOUCAULT 1	A,B,E,F,G,H,K,L,M,N Untill Ser.7051 PDX2017-01
22	0641805G00	0CA934	COMMUTATORE ALTMAN FOUCAULT 2 & 2.1	SELECTOR ALTMAN FOUCAULT 2 & 2.1	A,B,E,F,G,H,K,L,M,N From 7061 and RETRO- FIT KIT PDX2017-01

INDUZIONE TOP E700XP  
INDUCTION COOKING TOP E700XP

Pos	Factory Code	Spare Code	Descrizione	Description	Ref./Notes
22	0641805700	0C9695	COMMUTATORE GOTTAK ATICS	SELECTOR GOTTAK ATICS	C,D,I,J,O,P 230V
23	0657800600	0CA174	CAVO COMMUTATORE GOTTAK / GENERATORE FOUCAULT 1	CABLE SELECTOR GOTTAK / GENERATOR FOUCAULT 1	A,B,E,F,G,H,K,L,M,N Up to 7051
23	0657800900	0CA995	CAVO COMMUTATORE ALTMAN / GENERATORE FOUCAULT 2 & 2.1 E RETROFIT KIT	CABLE, SELECTOR ALTMAN / GENERATOR FOUCAULT 2 & 2.1 AND RETROFIT KIT	A,B,E,F,G,H,K,L,M,N From 7061 and RETROFIT KIT PDX2017-01
23	063889AP00	0C9696	CAVO COMMUTATORE / GENERATORE ATICS	CABLE, GOTTAK / GENERATOR ATICS	C,D,I,J,O,P 230V
24	0660808400	0C9697	LED LUCE VERDE	GREEN LED LAMP	
24	0660808500	0C9698	LED LUCE ROSSA	RED LED LAMP	
25	0548877W00	0C8700	MANOPOLA (CON ADATTATORE)	KNOB	ELX
25	0548878201	0C7232	MANOPOLA	KNOB	ZAN
25	0548865500	0A5621	MANOPOLA	KNOB	OEM
26	0151098052	088314	DETERGENTE REINIGER	CLEANER REINEGER	
27	0147098057	088313	PRIMER 1015 PACTAN	PRIMER 1015 PACTAN	
28	0147098058	0C0074	SILICONE	SILICONE	
29	0598849200	0C0024	TARGHETTA PACE MAKER	PACEMAKER STICKER	
30	FM9300	0ST068	ASTA PRENDITUTTO CON CALAMITA	GRABBER WITH MAGNET	
31	0516860702	0C0137	PIASTRA GIUNZIONE APPARECC.	JOINTING REAR PLATE	
31*	0217013405	0C8694	VITE M5X40MM	SCREW M5X40MM	



Electrolux Professional SPA  
Viale Treviso 15  
33170 Pordenone  
[www.electrolux-professional.com](http://www.electrolux-professional.com)

NordCap GmbH & Co. KG  
Thalendorststraße 15  
28307 Bremen  
Hauptsitz (Service, Finanzen & Personal, Lager, IT, Marketing)

Telefon: +49 421 48557-0  
Telefax: +49 421 488650  
E-Mail: [bremen@nordcap.de](mailto:bremen@nordcap.de)

Die NordCap Verkaufsniederlassungen in Deutschland:

Nord: Hamburg • Ost: Berlin • Süd: Ingelheim • West: Erkrath

by **NordCap**<sup>®</sup>

**ZANUSSI**  
PROFESSIONAL