

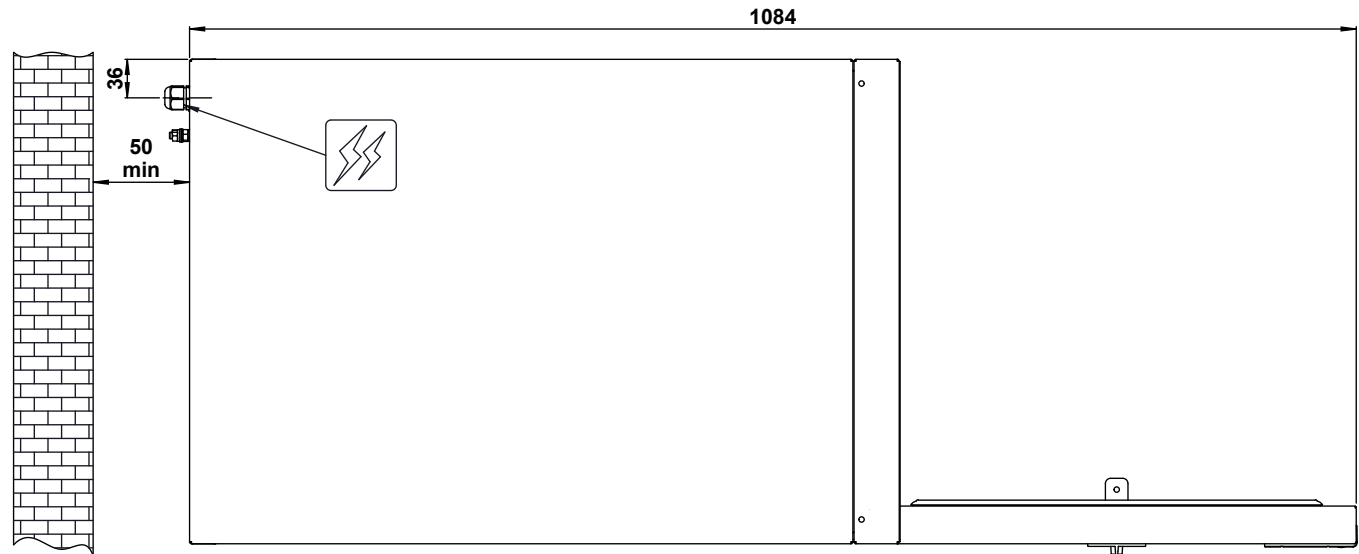

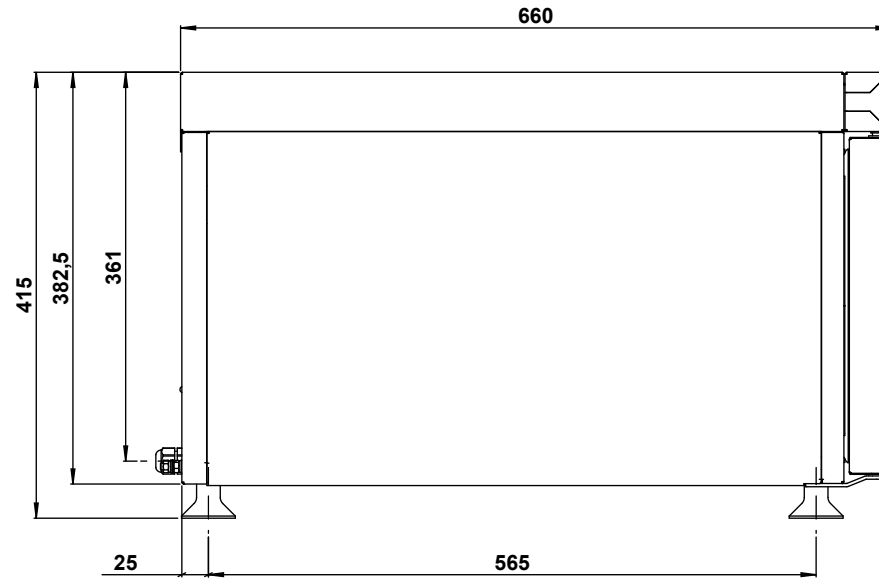

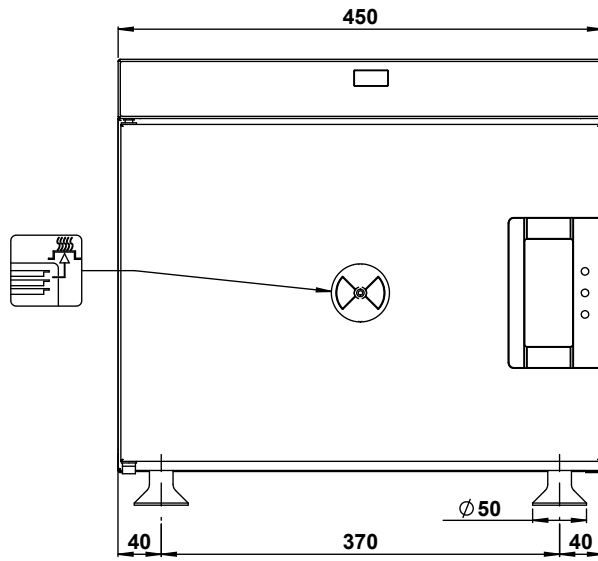

Masszeichnung

Niedertemperaturgarer CSC 031 E

[Artikel-Nr.: 437010031]



	IT	EN	ES	FR	DE	NL
	Ingresso cavo di alimentazione elettrica	Electricity supply cable inlet	Entrada cable alimentación	Entrée du câble d'alimentation électrique	Anschluß Elektrokabel	Inlaat voor de elektrische aansluiting
	Sfiato per fuoriuscita umidità in eccesso	Vent for excess humidity	Respiradero humedad en exceso	Évent automatique d'évacuation de l'humidité	Feuchtigkeits-entlüftung	Condens afvoerpijp
	Scarico camera	Chamber drain	Descarga cámara	Evacuation des liquides de l'enceinte	Garraumablauf	Kook kamer afvoer
	Ingresso acqua addolcita	Softened water inlet	Entrada agua ablandada	Arrivée d'eau adoucie	Anschluß enthärtetes Wasser	Inlaat voor onthard water
	Ingresso acqua	Water inlet	Entrada agua	Arrivée d'eau	Anschluß Wasser	Inlaat voor water
	Sfiato automatico evacuazione umidità in eccesso	Adjustable vent for excess humidity	Respiradero automático humedad	Soupape réglable pour l'évacuation de l'humidité	Automatische Feuchtigkeits-entlüftung	Automatisch gecontroleerde condensafvoer pijp
	Nota - Il disegno e le relative dimensioni sono riferite alla versione standard. Dotazioni a richiesta / accessori potrebbero comportare delle variazioni.	Important - Drawing and dimensions refer to the standard version. They may change with the addition of accessories or options.	Importante - Dibujo y dimensiones se refieren a la versión estándar. Pueden variar con accesorios y opciones.	Notez - Le plan et ses dimensions relatives se réfèrent à la version standard. Options sur demande/ accessoires comportent des variations.	Notiz - Zeichnung und Abmessung beziehen sich auf die Standard Version. Bei Zubehör und Optionen können sie ändern.	Notitie - Tekeningen en afmetingen hebben betrekking op de standaard uitvoering. Deze kunnen wijzigen bij gebruik van accessoires and opties.