

Schaltplan

Eiswürfelbereiter SDH 50 L

[Art. 41330510163]

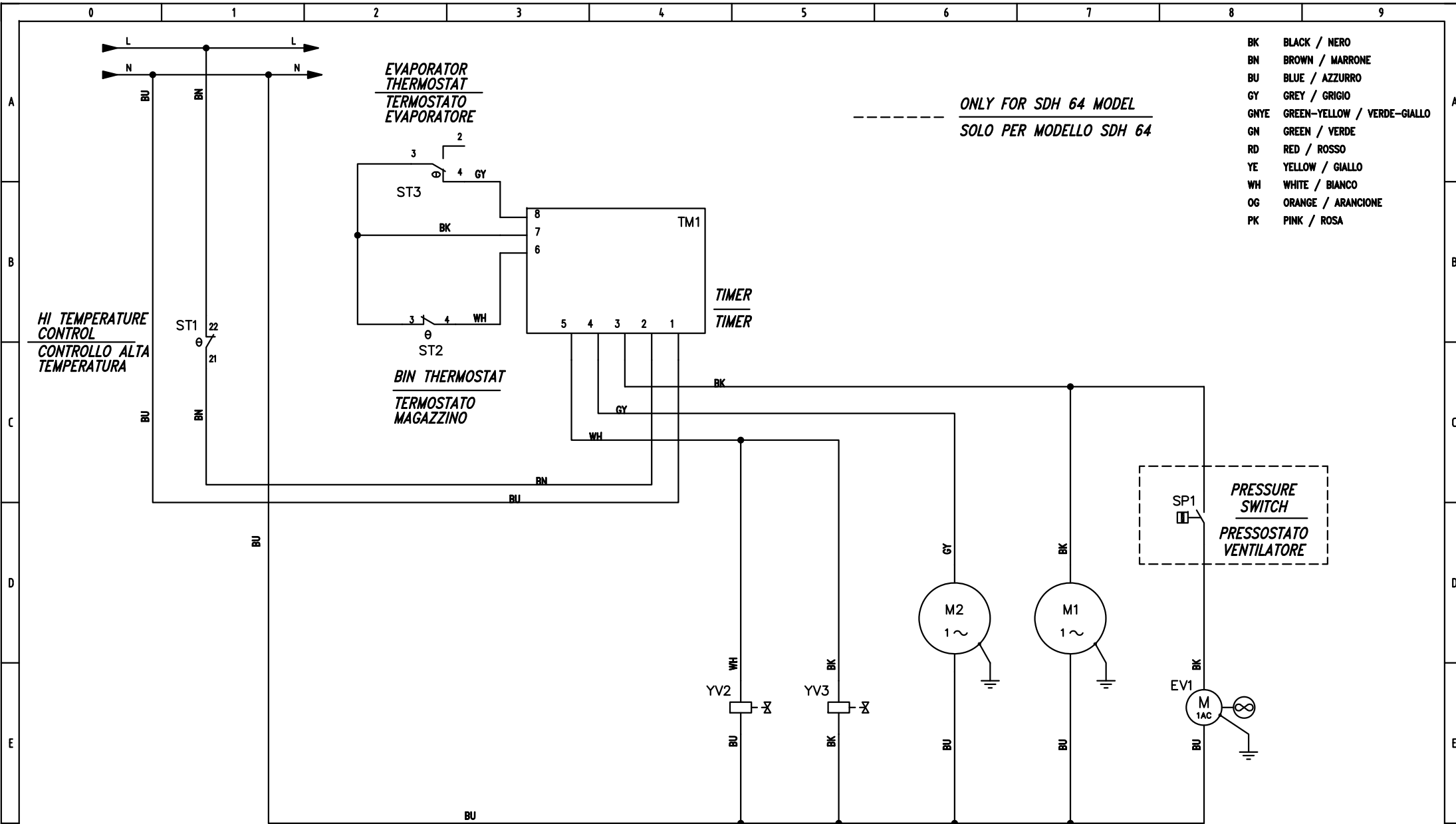



----- ONLY FOR SDH 64 MODEL
 SOLO PER MODELLO SDH 64

- BK BLACK / NERO
- BN BROWN / MARRONE
- BU BLUE / AZZURRO
- GY GREY / GRIGIO
- GNYE GREEN-YELLOW / VERDE-GIALLO
- GN GREEN / VERDE
- RD RED / ROSSO
- YE YELLOW / GIALLO
- WH WHITE / BIANCO
- OG ORANGE / ARANCIONE
- PK PINK / ROSA

00 - EMISSIONE

00	18_224	LB	12.12.18		DATA	12.12.18
					DISEGN.	L.BOCA
					VISTO	G.ROMAGNOLI
REV.	MODIFICA	SG	DATA	FIRMA	APPR.	G.ROMAGNOLI

SCHEMA ELETTRICO
 ELECTRICAL WIRING DIAGRAM

SDH 18/24/30/40/50/64













230 Vac 50/60 Hz

SOST. IL :	12.12.18	SOST. DA :	G.ROMAGNOLI	FILE :	05057830.DWG
------------	----------	------------	-------------	--------	--------------

050578-03

=	=
+	+
00	FG. 2
	F.S. 4

Sim.\Sym	Sigla\Item	Funzione\Use Type	Sim.\Sym	Sigla\Item	Funzione\Use Type	Sim.\Sym	Sigla\Item	Funzione\Use Type
	EV1	Fan motor Ventilatore						
	M1	Compressor Compressore						
	M2	Water pump Pompa acqua						
	ST1	HI Temperature control Controllo alta temperatura						
	ST2	Bin thermostat Termostato magazzino						
	ST3	Evaporator thermostat Termostato evaporatore						
	TM1	Electronic timer Timer elettronico						
	YV2	Water inlet valve Elettrovalvola ingresso acqua						
	YV3	Hot gas valve Elettrovalvola gas caldo						
	SP1	Fan pressure switch Pressostato ventilatore						

00 - EMISSIONE

00	18_224	LB	12.12.18		DATA	12.12.18	LEGENDA SIMBOLI SYMBOLS LEGEND			SDH 18/24/30/40/50/64	 Ice Systems	230 Vac 50/60 Hz		= =	
					DISEGN.	L.BOCA						+			
					VISTO	G.ROMAGNOLI						00		FG. 3	
REV.	MODIFICA	SG	DATA	FIRMA	APPR.	G.ROMAGNOLI	SOST. IL :	12.12.18	SOST. DA :	G.ROMAGNOLI	FILE :	05057830.DWG	050578-03		F.S. 4

Finanzen/Service
28307 Bremen
Thalenhorststraße 15
Tel.+49 421 48557-0
Fax+49 421 488650
bremen@nordcap.de

Vertrieb Ost
12681 Berlin
Wolfener Straße 32/34, Haus K
Tel.+49 30 936684-0
Fax+49 30 936684-44
berlin@nordcap.de

Vertrieb West
40699 Erkrath
Max-Planck-Straße 30
Tel.+49 211 540054-0
Fax+49 211 540054-54
erkrath@nordcap.de

Vertrieb Nord
21079 Hamburg
Großmoorbogen 5
Tel.+49 40 766183-0
Fax+49 40 770799
hamburg@nordcap.de

Vertrieb Süd
55218 Ingelheim
Hermann-Bopp-Straße 4
Tel.+49 6132 7101-0
Fax+49 6132 7101-20
ingelheim@nordcap.de



www.nordcap.de