

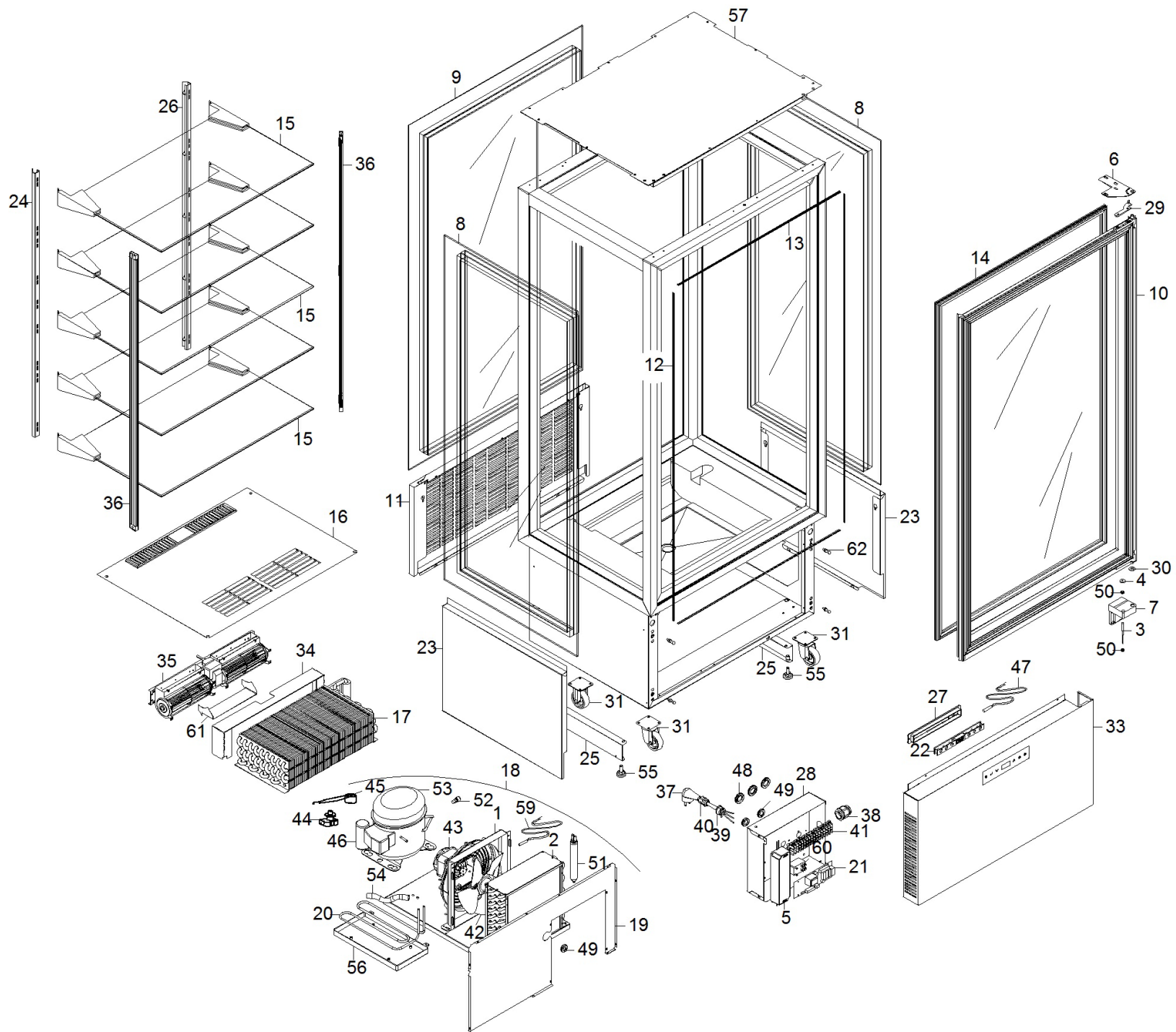























# Ersatzteilliste-Explosionszeichnung























## Panorama-Kühlvitrine LUXOR SCHWARZ

























[Art. 458100120]









	 	Bestellnummer		Beschreibung		Empf.	Menge	Gultigkeit datum
	1	3097420		VENTILATORSCH.			1	30/04/2014-
	2	3098250		KONDEN.+HAUBE			1	30/04/2014-
	3	3107780		MIKROSCHALTER		X	1	30/04/2014-
	4	3107790		MAGNET			1	30/04/2014-
	5	3202140		ALIMENTEUR ÉLECTRIQUE		X	1	30/10/2014-
	6	3187680		OBERKASTEN			1	30/04/2014-
	7	3181570		UNTERER BUEGEL			1	30/04/2014-
	8	6039230		GLAS			2	30/04/2014-
	9	6039220		GLAS			1	30/04/2014-
	10	6039210		TUER			1	30/04/2014-
	11	3210550		RÜCKWAND			1	30/04/2014-
	12	3163370		PROFIL			2	30/04/2014-
	13	3163380		PROFIL			2	30/04/2014-
	14	3163390		DICHTUNG		X	1	30/04/2014-
	15	3163480		EINLEGEBORETT			5	30/04/2014-
	16	3163500		UNTERE WAND			1	30/04/2014-
	17	3163530		VERDAMPFER		X	1	30/04/2014-
	18	3219870		AGGREGAT			1	30/04/2014-
	19	3375710		KUEHLERHAUBE			1	27/06/2018-
	20	3163620		SCHLANGE			1	30/04/2014-

	 	Bestellnummer		Beschreibung		Empf.	Menge	Gultigkeit datum
		21	3200830	ELEKTROKARTE		X	1	30/04/2014-
		22	3174890	ELEKTROKARTE		X	1	30/04/2014-
		23	3182800	SITLICHE WAND			2	30/04/2014-
		24	3164260	ZAHNSTANGE			1	30/04/2014-
		25	3181430	HALTER			2	30/04/2014-
		26	3164680	ZAHNSTANGE			1	30/04/2014-
		27	3172930	SCHUTZ			1	30/04/2014-
		28	3375700	SCHUTZHALHAUPTSCHALTER			1	27/06/2018-
		29	3187690	TÜR HALTERUNG			1	30/04/2014-
		30	3166060	UNTERLEGSSCHEIBE			1	30/04/2014-
		31	3264120	RAD			4	20/07/2017-
		32	0000000	-			0	09/09/2015-
		33	6063670	SCHALTERBLENDE			1	27/06/2018-
		34	3333640	KUEHLERHAUBE			1	16/09/2016-
		35	3333690	TANGENZ.VENTIL.		X	1	16/09/2016-
		36	6033340	LED-MODUL		X	2	30/10/2014-
		37	32A2200	SPEISEKABEL			1	30/04/2014-
		38	32D0220	ZUGENTLASTUNG			1	27/06/2018-
		39	32D0680	KABELHALTER			1	30/04/2014-
		40	32D0700	KABELZUGENTLASTUNG			1	30/04/2014-

	 	Bestellnummer		Beschreibung		Empf.	Menge	Gultigkeit datum
		41	32D0761	KLEMMBRETT		X	1	30/04/2014-
		42	32M2510	FLÜGELRAD		X	1	30/04/2014-
		43	32M7210	VENTILATORMOTOR		X	1	30/04/2014-
		44	32V1220	RELAY			1	30/04/2014-
		45	32V1370	MOTORSCHULTZS			1	30/04/2014-
		46	32V1500	KONDENSATOR		X	1	30/04/2014-
		47	32V6010	FÜHLER NTC		X	1	30/04/2014-
		48	32X0120	KABELDURCHFÜHRUNG			3	27/06/2018-
		49	32X0140	KABELDURCHFÜHRUNG			3	27/06/2018-
		50	32X0340	KABELDURCHFÜHRUNG			2	30/04/2014-
		51	33A0180	FILTER		X	1	30/04/2014-
		52	33A1200	BETRIEBSVENTIL		X	1	30/04/2014-
		53	3179300	KOMPRESSOR		X	1	30/04/2014-
		54	35X1640	SIPHONABLAß		X	1	30/04/2014-
		55	36C0630	FUß			4	30/04/2014-
		56	36Z2380	AUFFANGSCHAL			1	30/04/2014-
		57	3246820	HIMMEL COMPLETE			1	30/10/2014-
		58	0000000	-			0	27/06/2018-
		59	32V3730	FÜHLER NTC		X	1	30/04/2014-
		60	3251120	RELAY		X	1	30/10/2014-

	 	Bestellnummer		Beschreibung		Empf.	Menge	Gultigkeit datum
		61		3333650			1	16/09/2016-
		62		36G1140			4	27/06/2018-

NordCap GmbH & Co. KG  
Thalenhorststraße 15  
28307 Bremen  
Hauptsitz (Service, Finanzen & Personal, Lager, IT, Marketing)

Telefon: +49 421 48557-0  
Telefax: +49 421 488650  
E-Mail: [bremen@nordcap.de](mailto:bremen@nordcap.de)

Die NordCap Verkaufsniederlassungen in Deutschland:

Nord: Hamburg • Ost: Berlin • Süd: Ingelheim • West: Erkrath

