

## **Ersatzteilliste-Explosionszeichnung** **Umluft-Gewerbekühlschrank** **UKU 160 W**

[Art. 402729458]



## Refrigerated Counters 160 It R600a

Code	ECC	Model	Description	Ref	Page	Brand
110568	00	ZRUCR16X16	UNDERCOUNTER REF.160L,1 DOOR +2+10°C,S/S	o	2 3	Zanussi
110569	00	ZUCR16G1V	UNDERC. REF.160L,1 GL.DOOR +2+10°C, GREY	p	2 3	Zanussi
110570	00	ZUCR16W1	1-DOOR UNDERCOUNTER.REF.160L, +2+10°C,WHITE-R600a	q	2 3	Zanussi
110571	00	ZUCR16W1V	UNDERC. REF.160L,1 GL.DOOR +2+10°C,WHITE	r	2 3	Zanussi
110574	00	ZUCR16X1G6	UNDERC. REF.160L,1 DOOR +2+10°C,S/S-UK	s	2 3	Zanussi
110575	00	ZUCR16W1G6	UNDERC.REF.160L,1 DOOR +2+10°C,WHITE-UK	t	2 3	Zanussi
110578	00	ZUCR16X1LG6	UC. REF.160L,1 DOOR +2+10°C,S/S,LEFT-UK	u	2 3	Zanussi
727770	01	RUCR16CC	1-DOOR UNDERC.REF.160L,S/S-UK PLG-R600a	a	2 3	Electrolux
727771	01	RUCR16LCC	1-D.UC.REF160L,S/S-UK PLG,LFT HNG	b	2 3	Electrolux
727772	01	RUCR16G1VCC	1GL DR UC 160L 2/10°C-UK-MECH.THERM-COST	c	2 3	Electrolux
727788	00	RUCR16X16	1-DOOR UNDERCOUNTER REF.160L, +2+10°C,S/S-R600a	d	2 3	Electrolux
727789	00	RUCR16G1V6	1-GLASS DOOR UNDERC. REF.160L, +2+10°C, GREY-R600a	e	2 3	Electrolux
727790	00	RUCR16W16	1-DOOR UNDERCOUNTER.REF.160L, +2+10°C,WHITE R600a	f	2 3	Electrolux
727791	00	RUCR16W1V6	1-GLASS DOOR UNDERCOUNTER. REF.160L,+2+10°C,WHITE R600a	g	2 3	Electrolux
727794	00	RUCR16X1G6	UNDERC. REF.160L,1 DOOR +2+10°C,S/S-UK	h	2 3	Electrolux
727795	00	RUCR16W1G6	UNDERCOUNTER.REF.160L,1-DOOR +2+10°C,WHITE-UK-R600a	i	2 3	Electrolux
727798	00	RUCR16X1LG6	UC. REF.160L,1 DOOR +2+10°C,S/S,LEFT-UK	l	2 3	Electrolux
727799	01	RUCR16R6GK	1-DOOR UNDERCOUNTER REF.160L +2+10°C,S/S-UK R600a	m	2 3	Electrolux
727800	01	RUCR16L6GK	1-DOOR UNDERCOUNTER.REF.160L +2+10C S/S-UK LF.HING R600a	n	2 3	Electrolux
727968	00	RUCR16R6S	1-DOOR UNDERCOUNTER REF.160L +2+10°C,S/S- R600a	m	2 3	Electrolux
729456	00	ARUCR16X16	UNDERCOUNTER REF.160L,1 DOOR +2+10°C,S/S	v	2 3	Alpen
729457	00	AUCR16G1V	UNDERC. REF.160L,1 GL.DOOR +2+10°C, GREY	w	2 3	Alpen
729458	00	AUCR16W1	UNDERCOUNTER.REF.160L,1 DOOR +2+10°C,WHITE	x	2 3	Alpen
729459	00	AUCR16W1V	UNDERC. REF.160L,1 GL.DOOR +2+10°C,WHITE	y	2 3	Alpen
729462	00	AUCR16X1G6	UNDERC. REF.160L,1 DOOR +2+10°C,S/S-UK	z	2 3	Alpen
729463	00	AUCR16W1G6	UNDERC.REF.160L,1 DOOR +2+10°C,WHITE-UK	j	2 3	Alpen
729466	00	AUCR16X1LG6	UC. REF.160L,1 DOOR +2+10°C,S/S,LEFT-UK	k	2 3	Alpen

Pag. Indice  
2 Apparecchiatura refrigerata  
3 Lista ricambi

Index  
Freestanding refrigerated  
Spare parts list

Rev. 4

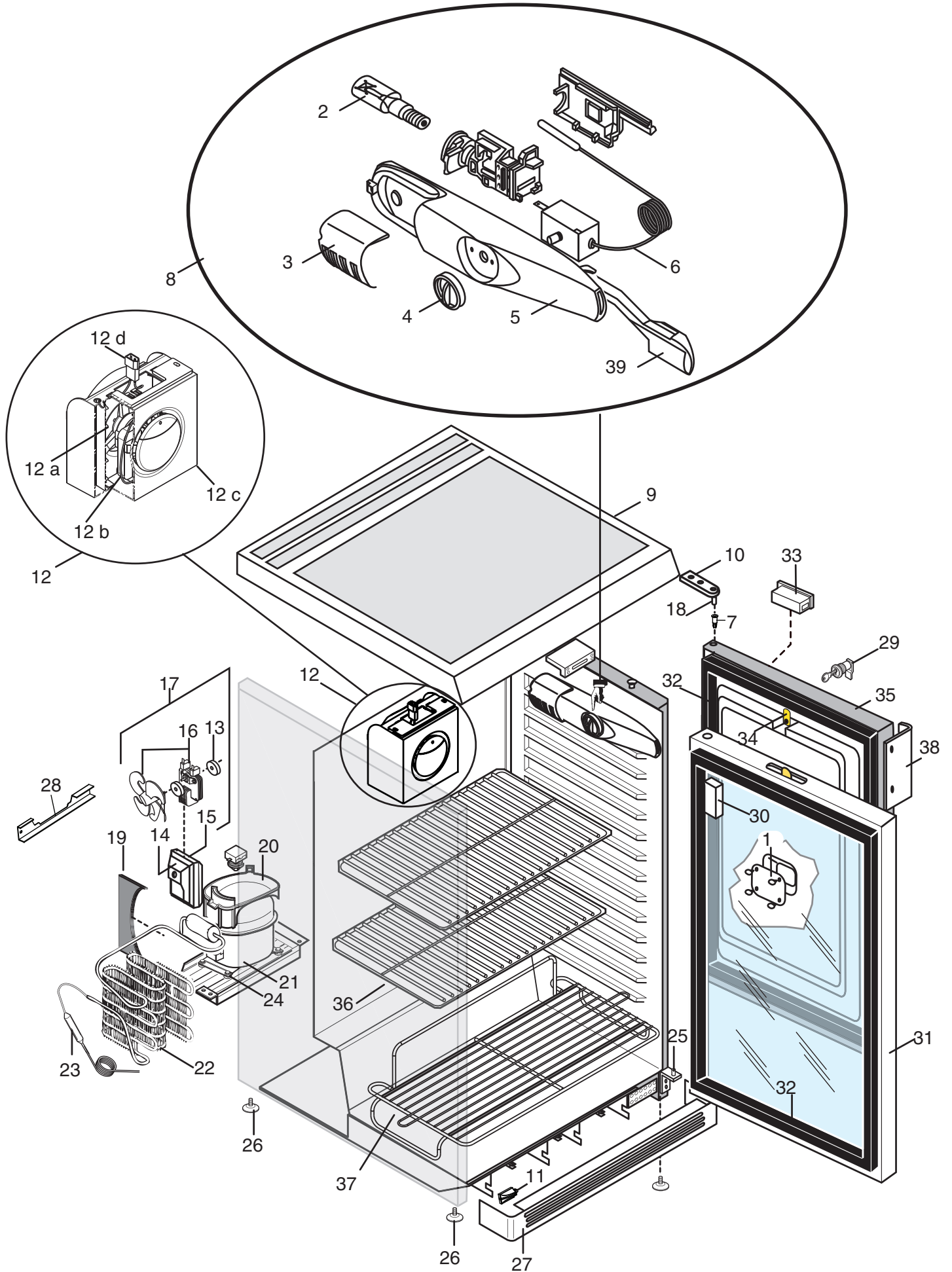

Pos	Code	Descrizione	Description	Ref. / Notes
1	094148	Copertura bulbo porta	Bulb cover door	all except c,g,r,y
2	091198	Lampada	Light	all
3	546R13900	Protezione lampada	Protection light	all
4	092786	Manopola termostato	Thermostat knob	all
5	546R13600	Scatola termostato	Thermostat box	all
6	091197	Termostato meccanico	Thermostat	all
7	095611	Boccola per porta	Door bush	all except c
8	092774	Guppo termostato TH LCC	Complete box and thermostat	all
9	091811	Piano di lavoro grigio	Top grey	a,b,d,e,h,k,l,o,p,s, u,v,w,z
9	095043	Piano di lavoro grigio	Top grey	c,m,n
9	091808	Piano di lavoro bianco	Top white	f,g,i,j,q,r,t,x,y
10	091752	Cerniera superiore	Upper hinge	all
11	092779	Tassello per zoccolo	Cover lower hinge	a,b,c,d,e,h,k,l,m,n, o,p,s,u,v,w,z
11	092776	Tassello per zoccolo	Cover lower hinge	f,g,i,j,q,r,t,x,y
12	<b>096532</b>	<b>Gruppo ventilatore cella DAC 50 Hz</b>	<b>Motor ventilator + fan 50 Hz</b>	<b>all</b>
12a	<b>096533</b>	<b>Assieme guscio posteriore</b>	<b>Rear cover assembly</b>	<b>all</b>
12b	<b>096535</b>	<b>Assieme ventilatore 50 Hz</b>	<b>Fan assembly 50 Hz</b>	<b>all</b>
12c	<b>096534</b>	<b>Assieme guscio anteriore</b>	<b>Front cover assembly</b>	<b>all</b>
12d	<b>096536</b>	<b>Morsetti</b>	<b>Terminal block</b>	<b>all</b>
13	091915	Gommino ventilatore	Rubber for motor ventilator	all
14	546R13300	Copertura ventilatore posterior.	Back protection fan	all
15	546R13200	Copertura ventilatore frontale	Front protection fan	all
16	093037	Ventilatore	Ventilator	all
17	832R08800	Kit Ventilatore	Kit Ventilator	all
18	091812	Perno per cerniera H=4,5 D=6	Pin for hinge	all
19	092771	Semianello ventilatore	Protection air	all
20	095606	Bacinella raccolta condensa	Condenser basin	all
21	095607	Compressore JIAXIPERA	Compressor JIAXIPERA	all
*	0A8171	Valvola di ricarica gas	Gas recharge valve	all
22	092770	Condensatore	Condenser	all
23	099949	Filtro deidratore 7 GR 2VIE	Dehydrator filter	all
24	092767	Gommino per compressore	Compressor Rubber	all
25	092775	Cerniera inferiore	Lower hinge	all except m
25	<b>093866</b>	<b>Cerniera inferiore</b>	<b>Lower hinge</b>	<b>m,n</b>
26	091721	Piedino livellatore	Foot	all
27	092778	Zoccolo	Plint	a,b,c,d,e,h,k,l,m,n, o,p,s,u,v,w,z
27	091814	Zoccolo	Plint	f,g,i,j,q,r,t,x,y
28	092769	Staffa blocc. compressore	Compressor stopper	all
29	091138	Serratura con chiave unica	Lock with one key for all	a,b,d,f,h,i,j,k,l,m,n, o,q,s,t,u,v,x,z
29	091805	Serratura	Lock	c,e,g,p,r,w,y
30	091141	Riscontro per micro cella	Switch block	c,e,g,p,r,w,y
31	092692	Ass. porta vetro completa	Glass door (grey)	c,e,p,w
31	092691	Ass. porta vetro completa	Glass door (white)	g,r,y
32	092689	Guarnizione porta	Gasket	all
33	094760	Termometro TLCD03 nero	Thermometer TLCD03 nero	a,b,d,f,h,i,j,k,l,o,q, s,t,u,v,x,z
33	095041	Termometro TR58X25L52	Thermometer TR58X25L52	c,m,n
34	091144	Leva per serratura	Lock lever	a,b,d,f,h,i,j,k,l,m,n, o,q,s,t,u,v,x,z
35	094397	Ass. porta schiumata	Foamed door	a,b
35	093174	Ass. porta schiumata	Foamed door	d,h,k,l,o,s,u,v,z
35	093173	Ass. porta schiumata	Foamed door	f,i,j,q,t,x
35	095042	Ass. porta schiumata	Foamed door	m,n
36	095643	Griglia	Shelf	all
37	095644	Griglia di fondo	Bottom shelf	all except for c,m,n
38	093071	Maniglia	Handle	a,b,m,n
38	099881	Maniglia	Handle	c,d,e,h,k,l,o,p,s,u, v,w,z

Pos	Code	Descrizione	Description	Ref. / Notes
38	091734	Maniglia	Handle	f,g,i,j,q,r,t,x,y
39	546R13700	Contro pulsante	Swicth button	all



NordCap GmbH & Co. KG  
Thalendorststraße 15  
28307 Bremen  
Hauptsitz (Service, Finanzen & Personal, Lager, IT, Marketing)

Telefon: +49 421 48557-0  
Telefax: +49 421 488650  
E-Mail: [bremen@nordcap.de](mailto:bremen@nordcap.de)

Die NordCap Verkaufsniederlassungen in Deutschland:

Nord: Hamburg • Ost: Berlin • Süd: Ingelheim • West: Erkrath



ALPENINOX