

Ersatzteilliste-Explosionszeichnung

Neutralelement **SE7 / 800T**

[Artikel-Nr.: 406372119]



**AMBIENT WORKTOP N700
NEUTRO N700**

PNC	Model	Ref	Brand	Pag.	Notes
178763	TN/1	a	Electrolux	2-6	AMBIENT WORKTOP WITH CLOSED FRONT 400 MM
178764	TN/2	b	Electrolux	2-6	AMBIENT WORKTOP WITH CLOSED FRONT 800 MM
178766	TN/3	c	Electrolux	2-6	AMBIENT WORKTOP WITH DRAWER 800 MM
178767	TNV/2	d	Electrolux	2-6	AMBIENT WORKTOP + OPEN BASE 800MM
178770	TN/0	f	Electrolux	2-6	AMBIENT WORKTOP WITH CLOSED FRONT 200 MM
178771	TNV/0	g	Electrolux	2-6	AMBIENT WORKTOP + OPEN BASE 200MM
371115	E7WTNBN000	h	Electrolux	2-6	AMBIENT WORKTOP WITH CLOSED FRONT 200 MM
371116	E7WTNDN000	i	Electrolux	2-6	AMBIENT WORKTOP WITH CLOSED FRONT 400 MM
371117	E7WTNDN00E	l	Electrolux	2-6	AMBIENT WORKTOP WITH DRAWER 400 MM
371118	E7WTNHN000	m	Electrolux	2-6	AMBIENT WORKTOP WITH CLOSED FRONT 800
371119	E7WTNHN00E	n	Electrolux	2-6	AMBIENT WORKTOP WITH DRAWER 800 MM
372115	Z7WTNBN000	o	Zanussi	2-6	AMBIENT WORKTOP WITH CLOSED FRONT 200
372116	Z7WTNDN000	p	Zanussi	2-6	AMBIENT WORKTOP WITH CLOSED FRONT 400
372117	Z7WTNDN00E	q	Zanussi	2-6	AMBIENT WORKTOP WITH DRAWER 400 MM
372118	Z7WTNHN000	r	Zanussi	2-6	AMBIENT WORKTOP WITH CLOSED FRONT 800
372119	Z7WTNHN00E	s	Zanussi	2-6	AMBIENT WORKTOP WITH DRAWER 800 MM
373115	A7WTNBN000	t	To brand	2-6	AMBIENT WORKTOP WITH CLOSED FRONT 200 MM
373116	A7WTNDN000	u	To brand	2-6	AMBIENT WORKTOP WITH CLOSED FRONT 400 MM
373117	A7WTNDN00E	v	To brand	2-6	AMBIENT WORKTOP WITH DRAWER 400 MM
373118	A7WTNHN000	x	To brand	2-6	AMBIENT WORKTOP WITH CLOSED FRONT 800 MM
373119	A7WTNHN00E	y	To brand	2-6	AMBIENT WORKTOP WITH DRAWER 800 MM

Pag	Index	Indice	Note
2-4	Frame and components	Struttura e componenti	
5-6	Spare parts list	Lista ricambi	

Brand/Marchio: All
Factory code: 9PDX

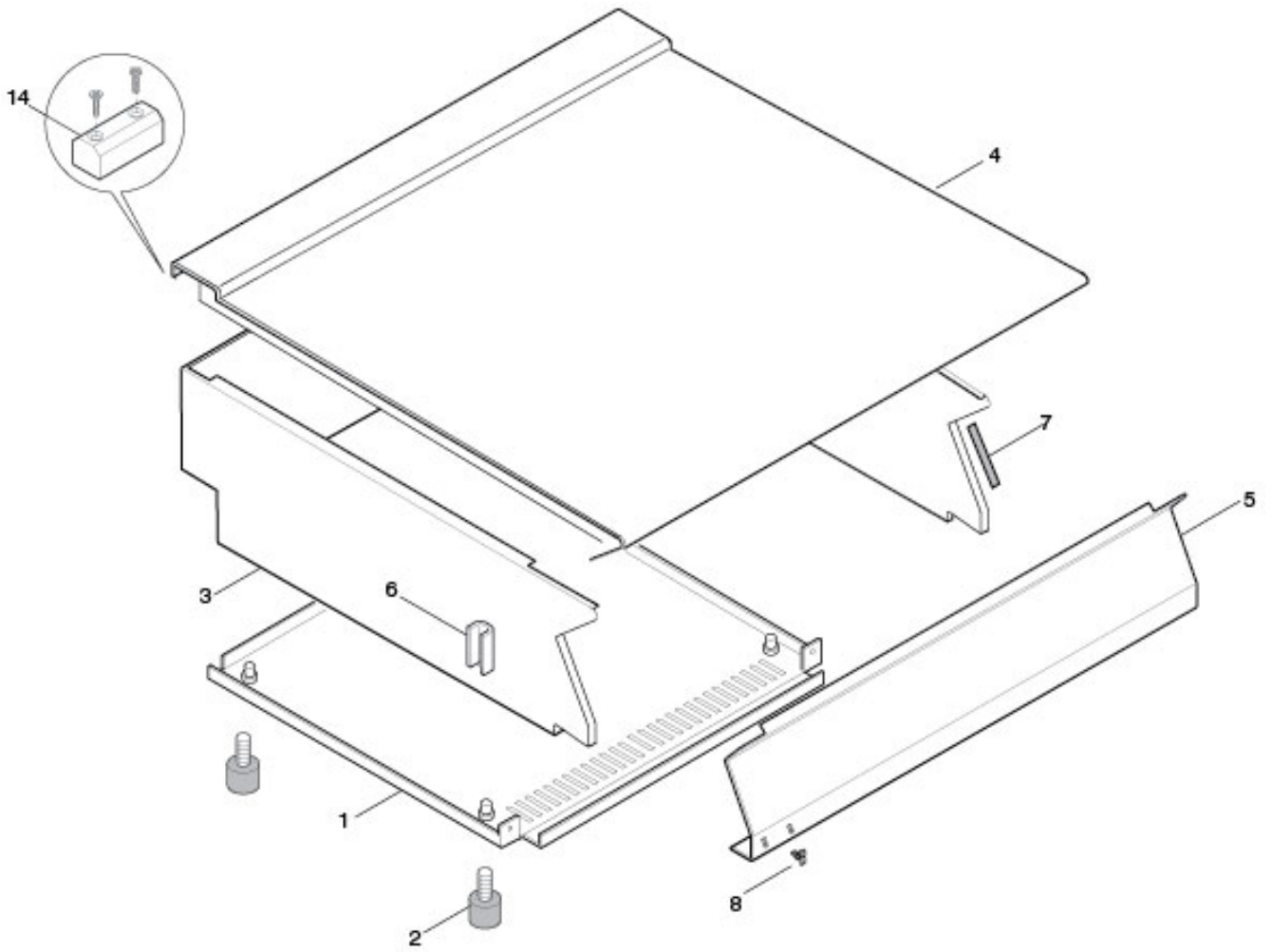

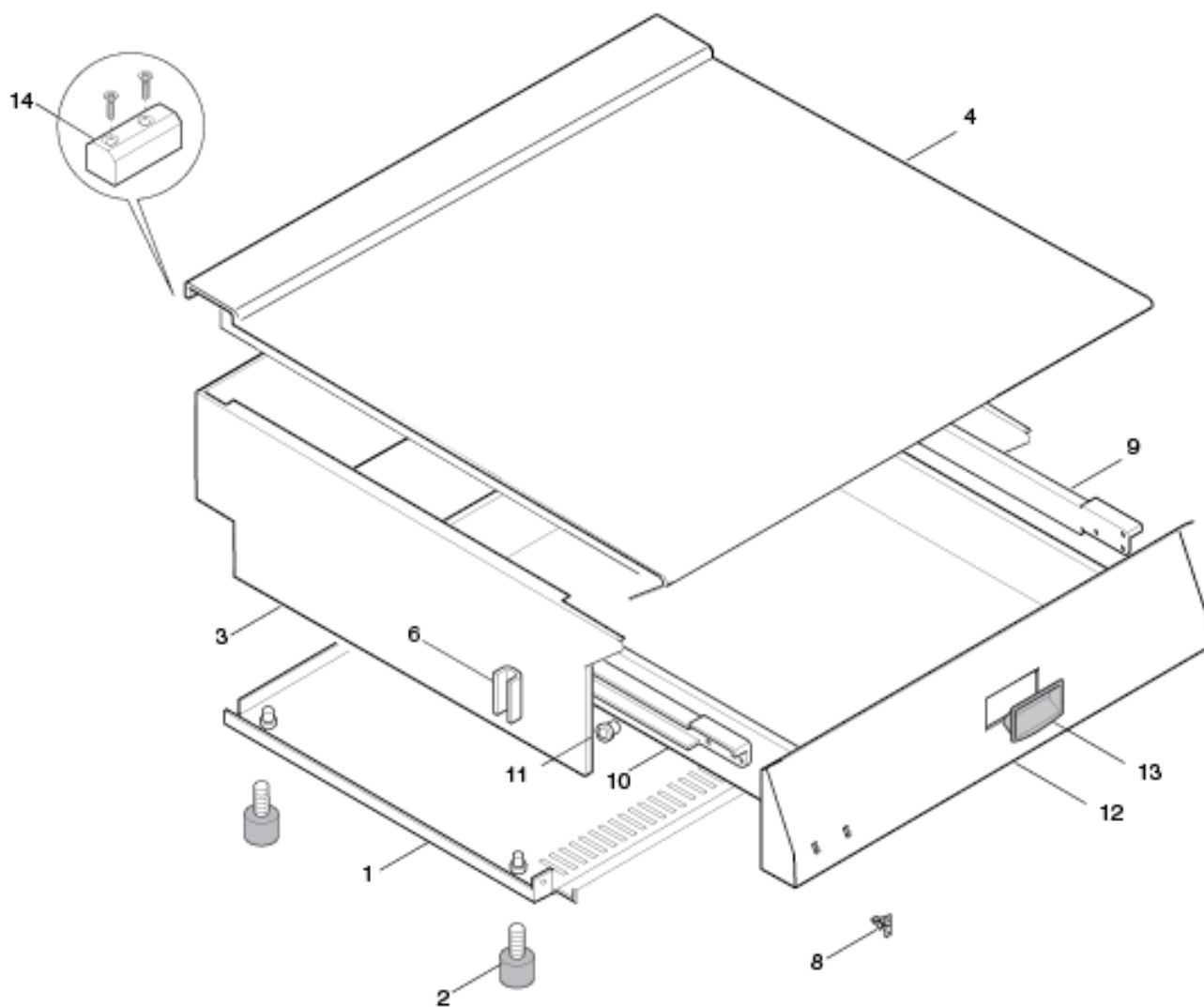

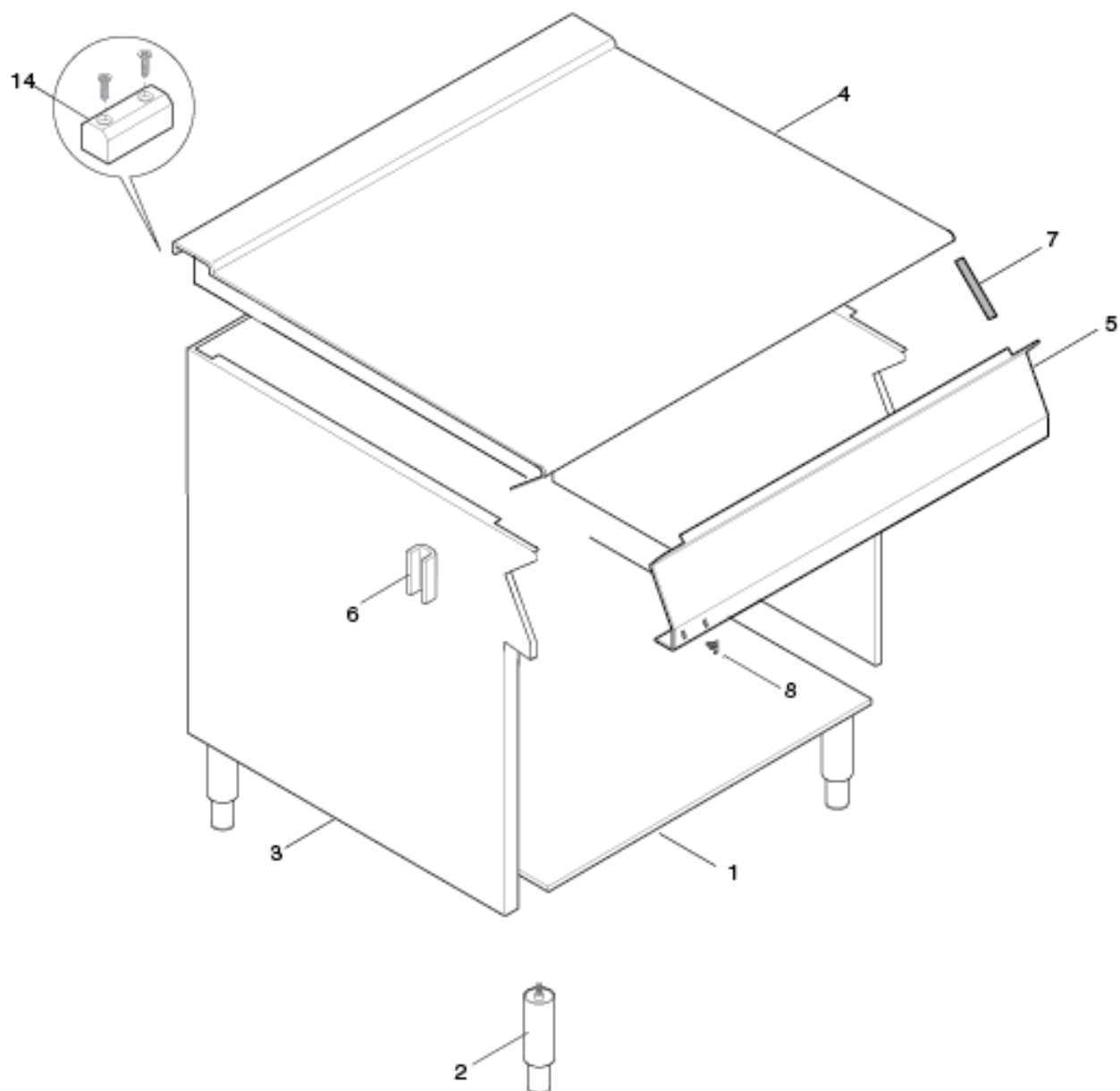

**WORKTOP N700
NEUTRO N700**

<i>Pos</i>	<i>Factory Code</i>	<i>Spare Part Code</i>	<i>Descrizione</i>	<i>Description</i>	<i>Ref./Note</i>
1	0532833400	*	FONDO TOP 200 MM	BOTTOM TOP 200 MM	f
1	0522897301	*	FONDO TOP 400 MM	BOTTOM TOP 400 MM	a up to 39/2007
1	0530865700	*	FONDO TOP 400 MM	BOTTOM TOP 400 MM	a from 40/2007
1	0522897401	*	FONDO TOP 800 MM	BOTTOM TOP 800 MM	b up to 39/2007
1	0530865800	*	FONDO TOP 800 MM	BOTTOM TOP 800 MM	b from 40/2007
1	0532833702	*	FONDO VANO 200 MM	BOTTOM OPEN BASE 200MM	g
1	0532872100	*	FONDO VANO 800 MM	BOTTOM OPEN BASE 400MM	d
1	0533835803	*	FONDO TOP CON CASSETTO 800MM	BOTTOM TOP WITH OPEN BASE 800MM	c
1	05038A2H01	*	FONDO TOP 200 MM	BOTTOM TOP 200 MM	h o t
1	05038A2J00	*	FONDO TOP 400 MM	BOTTOM TOP 400 MM	i p u
1	050289AN01	*	FONDO TOP + CASSETTO 400 MM	BOTTOM TOP + DRAWER 400 MM	l q v
1	05038A2K00	*	FONDO TOP 800 MM	BOTTOM TOP 800 MM	m r x
1	050289AP00	*	FONDO TOP + CASSETTO 800 MM	BOTTOM TOP + DRAWER 800 MM	n s y
2	0315252601	026806	PIEDINO	RUBBER FOOT	all except d and g
2	0835856900	0C0204	PIEDE	FOOT	d g
3	0532862700	*	RIVESTIMENTO LATERALE 200 MM	EXTERNAL PANEL 200MM	f
3	0530866801	0C5268	RIVESTIMENTO LATERALE 400MM	EXTERNAL PANEL 400MM	a
3	0530866901	0C5186	RIVESTIMENTO LATERALE 800MM	EXTERNAL PANEL 800MM	b
3	0532856200	*	RIVESTIMENTO LATERALE C/CASSETTO	EXTERNAL PANEL WITH DRAWER 800MM	c
3	0532862502	*	RIVESTIMENTO LATERALE MONOBLOCCO 200 MM	EXTERNAL PANEL FREESTANDING 200MM	g
3	0534836400	*	RIVESTIMENTO LATERALE MONOBLOCCO 800 MM	EXTERNAL PANEL FREESTANDING 800MM	d up to 39/2007
3	0530867902	0C6052	RIVESTIMENTO LATERALE MONOBLOCCO 800 MM	EXTERNAL PANEL FREESTANDING 800MM	d from 40/2007
3	085089J901	0C9853	RIVESTIMENTO TOP 200 MM	EXTERNAL PANEL TOP 200 MM	h
3	085089F701	0C8544	RIVESTIMENTO TOP 400 MM	EXTERNAL PANEL TOP 400 MM	i
3	050389MK03	*	RIVESTIMENTO TOP + CASSETTO 400 MM	EXTERNAL PANEL TOP + DRAWER 400 MM	l
3	085089F801	0C7536	RIVESTIMENTO TOP 800 MM	EXTERNAL PANEL TOP 800 MM	m
3	050389ML02	*	RIVESTIMENTO TOP + CASSETTO 800 MM	EXTERNAL PANEL TOP + DRAWER 800 MM	n
3	085089JA01	*	RIVESTIMENTO TOP 200 MM	EXTERNAL PANEL TOP 200 MM	o t
3	085089FA01	0C7268	RIVESTIMENTO TOP 400 MM	EXTERNAL PANEL TOP 400 MM	p u
3	050389MM01	*	RIVESTIMENTO TOP + CASSETTO 400 MM	EXTERNAL PANEL TOP + DRAWER 400 MM	q v
3	085089FB01	0C8464	RIVESTIMENTO TOP 800 MM	EXTERNAL PANEL TOP 800 MM	r x
3	050389MN01	*	RIVESTIMENTO TOP + CASSETTO 800 MM	EXTERNAL PANEL TOP + DRAWER 800 MM	s y
4	0873892400	0C4634	RIPIANO NEUTRO 200MM	TABLE TOP 200MM	f g
4	0873892200	0C4632	RIPIANO NEUTRO 400MM	TABLE TOP 400MM	a
4	0873892300	0C4633	RIPIANO NEUTRO 800MM	TABLE TOP 800MM	b c d
4	087089DV01	*	RIPIANO NEUTRO 200MM	TABLE TOP 200MM	h
4	087089DA02	*	RIPIANO NEUTRO 400MM	TABLE TOP 400MM	i l
4	087089DB02	0C7939	RIPIANO NEUTRO 800MM	TABLE TOP 800MM	m n
4	087089H001	0C7940	RIPIANO NEUTRO 200MM	TABLE TOP 200MM	o t

**WORKTOP N700
NEUTRO N700**

<i>Pos</i>	<i>Factory Code</i>	<i>Spare Part Code</i>	<i>Descrizione</i>	<i>Description</i>	<i>Ref./Note</i>
4	087089H103	0CB912	RIPIANO NEUTRO 400MM	TABLE TOP 400MM	p q u v
4	087089H203	0C7941	RIPIANO NEUTRO 800MM	TABLE TOP 800MM	r s x y
5	0831823101	0C4735	CRUSCOTTO 200 MM	CONTROL PANEL 200MM	f g
5	0831823201	0C4736	CRUSCOTTO 400MM	CONTROL PANEL 400MM	a
5	0831823301	0C4710	CRUSCOTTO 800MM	CONTROL PANEL 800MM	b d
5	0851818302	*	CRUSCOTTO 800MM	CONTROL PANEL 800MM	c
5	050389NM01	0TTZA9	CRUSCOTTO NEUTRO 200	CONTROL PANEL 200	h o t
5	085089BM02	0C7202	CRUSCOTTO NEUTRO + MARCHIATURA ELUX 400	CONTROL PANEL ELUX 400	i
5	085089GZ03	0C9842	CRUSCOTTO NEUTRO + MARCHIATURA ELUX 400	CONTROL PANEL ELUX 400	l
5	085089BK02	0C7818	CRUSCOTTO NEUTRO + MARCHIATURA ELUX 800	CONTROL PANEL ELUX 800	m
5	085089H003	0C9145	CRUSCOTTO NEUTRO + MARCHIATURA ELUX 800	CONTROL PANEL ELUX 800	n
5	085089G801	0C7206	CRUSCOTTO NEUTRO + MARCHIATURA ZAN 400	CONTROL PANEL ZAN 400	p
5	085089H103	0CA409	CRUSCOTTO NEUTRO + MARCHIATURA ZAN 400	CONTROL PANEL ZAN 400	q
5	087089GP01	0C7611	CRUSCOTTO NEUTRO + MARCHIATURA ZAN 800	CONTROL PANEL ZAN 800	r
5	085089H203	*	CRUSCOTTO NEUTRO + MARCHIATURA ZAN 800	CONTROL PANEL ZAN 800	s
5	085089G702	0CA037	CRUSCOTTO NEUTRO + FORATURA OEM 400	CONTROL PANEL OEM 400	u
5	085589F902	0C9683	CRUSCOTTO NEUTRO + FORATURA OEM 400	CONTROL PANEL OEM 400	v
5	087089HS01	*	CRUSCOTTO NEUTRO + MARCHIATURA OEM 800	CONTROL PANEL OEM 800	x
5	085589FA02	*	CRUSCOTTO NEUTRO + FORATURA OEM 800	CONTROL PANEL OEM 800	y
6	0527850500	0C0156	PIASTRINA RINFORZO FIANCHI	SIDE PANEL JOINTING PALTE	all
7	0140088006	*	GUARNIZIONE	GASKET, CONTROL PANEL	a b c d f g h i m o p r t u x up to 45/2012 a b c d f g
8	0518801801	053342	MOLLA PER MARCHIO	SPRING FOR BRAND	
9	0533835301	0C2717	GUIDA DESTRA CASSETTO	RIGHT DRAWER RUNNER	c up to 12/2009
10	0533835401	0C2715	GUIDA SINISTRA CASSETTO	LEFT DRAWER RUNNER	c up to 12/2009
9+10	0835847500	006109	COPPIA GUIDE CASSETTO	DRAWER RUNNERS	c from 13/2009
9+10	0835875200	0C7845	COPPIA GUIDE CASSETTO	DRAWER RUNNERS	l n q s v y
11	0541812501	0C4266	ROTELLA GUIDA CASSETTO	ROLLER FOR DRAWER RUNNER	c up to 12/2009
12	0851816804	*	CASSETTO	DRAWER	c
12	085089DK00	*	CASSETTO 400MM	DRAWER 400 MM	l q v
12	085089DL00	*	CASSETTO 800MM	DRAWER 800 MM	n s y
13	0548861302	0C2016	MANIGLIA CASSETTO	DRAWER HANDLE	c
13	054887AH00	0C8769	MANIGLIA CASSETTO ELUX	DRAWER HANDLE ELUX	l n
13	054887A802	0C8190	MANIGLIA CASSETTO ZAN	DRAWER HANDLE ZAN	q s y
14	0516860700	0C0137	PIASTRINA DI UNIONE	JOINTING REAR PLATE	a b c d f g

Finanzen/Service

28307 Bremen
Thalendorststraße 15
Tel.+49 421 48557-0
Fax+49 421 488650
bremen@nordcap.de

Vertrieb Ost

12681 Berlin
Wolfener Straße 32/34, HausK
Tel.+49 30 936684-0
Fax+49 30 936684-44
berlin@nordcap.de

Vertrieb West

40699 Erkrath
Max-Planck-Straße 30
Tel.+49 211 540054-0
Fax+49 211 540054-54
erkrath@nordcap.de

Vertrieb Nord

21079 Hamburg
Großmoorbogen 5
Tel.+49 40 766183-0
Fax+49 40 770799
hamburg@nordcap.de

Vertrieb Süd

55218 Ingelheim
Hermann-Bopp-Straße 4
Tel.+49 6132 7101-0
Fax+49 6132 7101-20
ingelheim@nordcap.de



www.nordcap.de